

ARCHMI-9XXB Series

12.1", 12.1W", 15", 15.6", 17", 18.5", 19", 21.5", and 32" Intel Whiskey Lake
Fanless Industrial Compact Size Panel PC

User Manual

Release Date

Sep.2022

Revision

V1.1

©2022 Aplex Technology, Inc.

All Rights Reserved.

Published in Taiwan

Aplex Technology, Inc.

15F-1, No.186, Jian Yi Road, Zhonghe District, New Taipei City 235, Taiwan

Tel: 886-2-82262881 Fax: 886-2-82262883 URL: <http://www.aplaxtec.com/zh/home.php>

Revision History

Reversion	Date	Description
1.0	2022/04/06	Initiation
1.1	2022/9/21	Updated power consumption and net weight

Warning!

This equipment generates uses and can radiate radio frequency energy and if not installed and used in accordance with the instructions manual, it may cause interference to radio communications. It has been tested and found to comply with the limits for a Class A computing device pursuant to FCC Rules, which are designed to provide reasonable protection against such interference when operated in a commercial environment. Operation of this equipment in a residential area is likely to cause interference in which case the user at his own expense will be required to take whatever measures may be required to correct the interference.

Electric Shock Hazard – Do not operate the machine with its back cover removed. There are dangerous high voltages inside.

Caution

Risk of explosion if the battery is replaced with an incorrect type.

Batteries should be recycled where possible. Disposal of used batteries must be in accordance with local environmental regulations.

Disclaimer

This information in this document is subject to change without notice. In no event shall Apex Technology Inc. be liable for damages of any kind, whether incidental or consequential, arising from either the use or misuse of information in this document or in any related materials.

Safety Precautions

Follow the messages below to prevent your systems from damage:

- ◆ Avoid your system from static electricity on all occasions.
- ◆ Prevent electric shock. Don't touch any components of this card when the card is power-on. Always disconnect power when the system is not in use.
- ◆ Disconnect power when you change any hardware devices. For instance, when you connect a jumper or install any cards, a surge of power may damage the electronic components or the whole system.

Table of Contents

Revision History	1
Warning!	2
Safety Precautions	3
Chapter 1 System Product	6
1.1 Features	6
1.2 Specifications	6
1.3 COM port definition	8
1.4 Standard LCD.....	9
1.5 High Brightness LCD	10
1.6 Power Consumption and PoE Application	11
1.7 Dimensions	12
1.8 Brief Description of ARCHMI-9XXB Series	16
1.9 Installation of HDD for 32"	23
1.10 VESA Mounting.....	24
1.11 Panel Mounting	24
Chapter 2 Hardware	25
2.1 Specifications	25
2.2 Board Dimensions	28
2.3 Jumpers and Connectors Location	29
2.4 Jumpers Setting and Connectors	29
Chapter 3 BIOS Setup Description	42
3.1 Operations after POST Screen	42
3.2 BIOS SETUP UTILITY	42
3.3 Main Settings	43
3.4 Advanced Settings	44
3.5 Chipset Settings	53
3.6 Security Settings	61
3.7 Boot Settings.....	63
3.8 Save & Exit Settings.....	64
Chapter 4 Installation of Drivers	66
4.1 Intel Chipset	67
4.2 Intel® HD Graphics Chipset	70
4.3 Realtek HD Audio Driver Installation	73
4.4 Intel® Management Engine Interface	74
4.5 LAN Driver.....	77
4.6 Touch Screen Installation.....	79

LIST OF FIGURES

FIGURE 1.1 DIMENSIONS OF ARCHMI-912BP/BR (H).....	12
FIGURE 1.2 DIMENSIONS OF ARCHMI-912WBP/WBR (H)	12
FIGURE 1.3 DIMENSIONS OF ARCHMI-915BP/BR (H).....	13
FIGURE 1.4 DIMENSIONS OF ARCHMI-916BP/BR (H).....	13
FIGURE 1.5 DIMENSIONS OF ARCHMI-917BP/BR (H).....	14
FIGURE 1.6 DIMENSIONS OF ARCHMI-918BP/BR (H).....	14
FIGURE 1.7 DIMENSIONS OF ARCHMI-919BP/BR (H).....	15
FIGURE 1.8 DIMENSIONS OF ARCHMI-921BP/BR (H).....	15
FIGURE 1.9 DIMENSIONS OF ARCHMI-932BP.....	16
FIGURE 1.10 FRONT VIEW OF ARCHMI-912BP/R(H).....	17
FIGURE 1.11 REAR VIEW OF ARCHMI-912BP/R(H)	17
FIGURE 1.12 FRONT VIEW OF ARCHMI-915BP/R(H).....	17
FIGURE 1.13 REAR VIEW OF ARCHMI-915BP/R(H).....	18
FIGURE 1.14 FRONT VIEW OF ARCHMI-916BP/R(H).....	18
FIGURE 1.15 REAR VIEW OF ARCHMI-916BP/R(H).....	18
FIGURE 1.16 FRONT VIEW OF ARCHMI-917BP/R(H).....	19
FIGURE 1.17 REAR VIEW OF ARCHMI-917BP/R(H).....	19
FIGURE 1.18 FRONT VIEW OF ARCHMI-918BP/R(H).....	19
FIGURE 1.19 REAR VIEW OF ARCHMI-918BP/R(H).....	20
FIGURE 1.20 FRONT VIEW OF ARCHMI-919BP/R(H).....	20
FIGURE 1.21 REAR VIEW OF ARCHMI-919BP/R(H).....	20
FIGURE 1.22 FRONT VIEW OF ARCHMI-921BP/R(H).....	21
FIGURE 1.23 REAR VIEW OF ARCHMI-921BP/R(H).....	21
FIGURE 1.24 FRONT VIEW OF ARCHMI-932BP	21
FIGURE 1.25 REAR VIEW OF ARCHMI-932BP	22
FIGURE 1.26 ARCHMI-9xxB SERIES VESA MOUNTING.....	24
FIGURE 1.27 ARCHMI-9xxB SERIES PANEL MOUNTING.....	24

1.1 Features

- Industrial Compact Size Panel PC
- Flat front panel touch screen
- Fanless Design
- Intel Whiskey Lake i3-8145UE/i5-8365UE CPU (4305UE, i7-8665UE series by project)
- One SO-DIMM Slot up to 32GB DDR4 2400MHz
- DC 9~36V / AC 90~264V (only 32") wide-ranging power input
- IP66 compliant front panel
- Optional projected capacitive touchscreen support 7H anti-scratch surface
- Support High brightness LCD

1.2 Specifications

ARCHMI-9XXB	
System	
CPU	Intel 8th Gen. Core i7/i5/i3 Processors Core i3-8145UE (2C/4T, 2.20 GHz, 15W TDP) Core i5-8365UE (4C/8T, 1.60 GHz, 15W TDP), optional Core i7-8665UE (4C/8T, 1.70 GHz, 15W TDP), for project base Celeron 4305UE for project base
Chipset	SoC
Memory	1 x 260-pin SO-DIMM, up to 32GB DDR4 2133MHz FSB(4305UE) up to 32GB DDR4 2400MHz FSB(i38145UE/i58365UE/i78665UE) * ARCHMI-932BP must install RAM for factory default
Graphic	Intel® UHD Graphics 610 (4305UE) Intel® UHD Graphics 620 (i3-8145UE/i5-8365UE/i7-8665UE)
IO Port	
USB	4 x USB 3.0 type A
Serial/Parallel	1 x RS-232 pin1 RTS/5V/12V selectable via jumper (COM1), 1 x RS-232/422/485 port (COM2), in 1x DB9 connector (COM1_2)
Audio	1 x Audio Line Out
LAN	2 x GbE LAN RJ-45 (i5/i7 support vPro, option)
DP	1 x DP Port
Power	1 x 3-pin DC Power Input terminal 1 x 2-pin connector for power on/off button

Option	<p>TB-528 Series:</p> <ol style="list-style-type: none"> 1. 4 x USB2.0 type A (TB-528U4) 2. 1 x COM(RS-232) + 2 x USB2.0 + 1 x Mini PCIe slot(TB-528C1U2P1) 3. 2 x CAN (TB-528CAN2) 4. 2 x COM(RS-232) + 1 x Mini-PCIe slot (TB-528C2ME1) <p>UPS Battery (Turbo OFF in BIOS)</p> <p>Speaker (Through TB-38)</p> <p>Auto Dimming (Through TB-38)</p> <p>GPIO (4xDI, 4xDO, through TB-542)</p> <p>WIFI (Through M.2 converter to mPCIe module)</p> <p>(I/O Board TB-528 Series and UPS can only be either one choice in 12.1" models)</p>
Storage Space	
Storage	<p>1 x M.2 M Key (PCIex4/SATA III Auto Detect), for 2242 (Default, Easy Accessible); 2280 (exclusive TB-528 series)</p> <p>1 x 2.5" SATAIII HDD (Option, by project)</p>
Expansion	
Expansion Slot	<p>1 x Internal Mini-PCIe slot full size (PCIe3.0x1, USB2.0, SMBus, SIMBus)</p> <p>1 x Nano SIM card holder</p>
Touch Screen – Resistive Touch Window Type (not for 32")	
TS Control	PenMount 6000 on Board
Interface	USB
Light Transmission	80%
Touch Screen – Projected Capacitive Type	
TS Control	Chip on tail
Interface	USB
Light Transmission	90%
Wireless LAN and Antenna	
Wireless LAN	LTE via Mini-PCIe module card full-size(option) Rear cover design Antenna hole
Antenna	4 x SMA-female connector's holes for external antenna
Power	
Power Input	<p>DC 9~36V</p> <p>AC 90~264V for ARCHMI-932BP</p>
Backup Battery	
Backup battery	<p>21W(option)</p> <p>*When the Backup battery is installed; it cannot run full loading program; it may cause the system shot down</p>
Mechanical	
Mechanical Construction	<p>Aluminum die-casting chassis(12.1"~15.6"+21.5")</p> <p>Aluminum front bezel/Aluminum die-casting for back cover(17"~19")</p>
Front Bezel Metal	Aluminum/Panel Mounting(32")
Mounting	<p>VESA Mount 100 x 100</p> <p>VESA Mount 200 x 200 only for 32"</p>

Chassis Color	RAL 9007
IP Rating	Front Panel IP66
Operating System Support	
OS Support	Windows 10 IoT Enterprise Yocto Linux Linux Ubuntu 20.04 above
Environmental	
Operating Temperature	0~50°C/-20°C to 60°C optional
Storage Temperature	-20~60°C
Humidity	10 to 95% @ 40°C, non-condensing
Certification	Meet CE / FCC Class A

1.3 COM port definition

Pin#	COM1 (RS232)	COM2 (RS232)	COM2 (RS422)	COM2 (RS485)
1	RTS/5V/12V			
2	RX			
3	TX			
4	CTS			
5	GND	GND		
6		<u>TX</u>	<u>RX+</u>	
7			<u>RX-</u>	
8			<u>TX-</u>	<u>D-</u>
9		<u>RX</u>	<u>TX+</u>	<u>D+</u>

1x RS232, pin1 RTS/5V/12V selectable via jumper (COM1), jumper setting please refer to the [18. JP2](#):

1x RS232/422/485 port(COM2), in 1xDB9 connector (COM1_2)

2507009001000000	COM port Y cable DSUB/DSUB 9P(F) TO (M)×2 FOR Volt /RS232 L=10cm	Default
4507009001000001	COM port Y cable (optional) DSUB/DSUB 9P(F) TO (M)×2 FOR RTS L=10cm	Optional

WARNING: If the wrong Y cable is used, it may damage the device

1.4 Standard LCD

	ARCHMI-912BP/R	ARCHMI-912WBP/R	ARCHMI-915BP/R	ARCHMI-916BP/R	ARCHMI-917BP/R
Display Type	12.1" TFT LCD	12.1"W TFT LCD	15" TFT LCD	15.6" TFT LCD	17" TFT LCD
Max. Resolution	800 x 600 1024 x 768	1280 x 800	1024 x 768	1366 x 768 1920 x 1080	1280 x 1024
Max. Color	16.2M	16.7M	16.2M/16.7M	16.7M/16.2M	16.2M/16.7M
Luminance(cd/m ²)	450-SVGA 500-XGA	600	300	400-HD 450-FHD	350
Contrast Ratio	1500:1-SVGA 1000:1-XGA	1000:1	2000:1	500:1-HD 800:1-FHD	1000:1
Viewing angle(H/V)	178 /178	170 /170	168 / 168	170 / 160	178 / 178
Backlight Lifetime (Hrs)	50,000-SVGA 30,000-XGA	50,000	50,000	50,000	30,000
Power Consumption	MAX:56W	MAX:50W	MAX:60W	MAX:60W	MAX:86W
Mounting	VESA Mount 100 x 100				
Dimensions(mm)	319x245x51.7	328x227x57.6	410x310x54.67	412x277.5x58.9	439x348x64.8
Net Weight(Kg)	2.8	2.9	4.4	4.5	6.3

	ARCHMI-918BP/R	ARCHMI-919BP/R	ARCHMI-921BP/R	ARCHMI-932BP
Display Type	18.5" TFT LCD	19" TFT LCD	21.5" TFT LCD	32" TFT LCD
Max. Resolution	1366 x 768 1920x1080	1280 x 1024	1920 x 1080	1920 x 1080
Max. Color	16.7M	16.7M	16.7M	16.7M
Luminance(cd/m ²)	300	350	250	500
Contrast Ratio	1000:1	1000:1	3000:1	3000:1
Viewing angle(H/V)	170/170	170/160	178/178	178/178
Backlight Lifetime (Hrs)	50,000	50,000	30,000	30,000
Power Consumption	MAX:70W	MAX:82W	MAX:74W	MAX:75W
Mounting	VESA Mount 100 x 100			VESA 200 x 200
Dimensions(mm)	499.6x314.6x65.4	468x380x64.8	557x362x64.8	810x490x65
Net Weight	6.7	7.3	7.5	17.4

1.5 High Brightness LCD

	ARCHMI-912BP/RH	ARCHMI-912WBP/RH	ARCHMI-915BP/RH	ARCHMI-916BP/RH	ARCHMI-917BP/R/GH
Display Type	12.1" TFT LCD	12.1"W TFT LCD	15" TFT LCD	15.6" TFT LCD	17" TFT LCD
Max. Resolution	800 x 600 1024 x 768	1280 x 800	1024 x 768	1366 x 768 1920 x 1080	1280 x 1024
Max. Color	16.2M	16.7M	16.7M	16.7M 16.2M	16.7M
Luminance(cd/m ²)	1000				
Contrast Ratio	700:1	1000:1	3000:1	500:1-HD 800:1-FHD	1000:1
Viewing angle(H/V)	178/178-SVGA 160/140-XGA	176/176	176/176	160/160-HD 170/170-FHD	170/160
Backlight Lifetime (Hrs)	50,000	50,000	70,000	50,000	50,000
Mounting	VESA Mount 100 x 100				
Dimensions(mm)	319x245x51.7	328x227x57.6	410x310x54.67	412x277.5x58.9	439x348x64.8
Net Weight(Kg)	2.7	TBD	4.29	4.32	6.01

	ARCHMI-918BP/RH	ARCHMI-919BP/RH	ARCHMI-921BP/RH
Display Type	18.5" TFT LCD	19" TFT LCD	21.5" TFT LCD
Max. Resolution	1366 x 768	1280 x 1024	1920 x 1080
Max. Color	16.7M	16.7M	16.7M
Luminance(cd/m ²)	1000		
Contrast Ratio	1000:1	1000:1	1000:1
Viewing angle(H/V)	170/160	170/160	178/178
Backlight Lifetime (Hrs)	50,000	50,000	50,000
Mounting	VESA Mount 100 x 100		
Dimensions(mm)	499.6x314.6x65.4	468x380x64.8	557x362x64.8
Net Weight	TBD	7.58	7.45

1.6 Power Consumption and PoE Application

Max power consumption of each model

Model	Max Power Consumption	PoE+(30W)	PoE++(45W)
ARCHMI-912B	56	n	y*
ARCHMI-912WB	50	n	n
ARCHMI-915B	60	n	n
ARCHMI-916B	60	n	n
ARCHMI-917B	86	n	n
ARCHMI-918B	70	n	n
ARCHMI-919B	82	n	n
ARCHMI-921B	74	n	n
ARCHMI-932B	75	n	n

- * Max Power Consumption: Backlight bright setting 100%,+Turbo on+ System full loading with full rear IO connectors.
- * Power consumption may have 10% tolerance difference due to different MB, parts, test instrument, and so on.
- * y* means: system turbo off+ rear IO no loading+ LED backlight down to 70%, and the PSE cable connect to the system needs to be shorter than 50m. If you need some IO loading, please find your sales representative to discuss.
- * y* does not apply in Linux OS.
- * We suggest to use the adapter that Apex approved. If you would like to adopt your own power supply or adapter, please add another 20-30% from the above power consumption to make sure the system can work correctly.

1.7 Dimensions

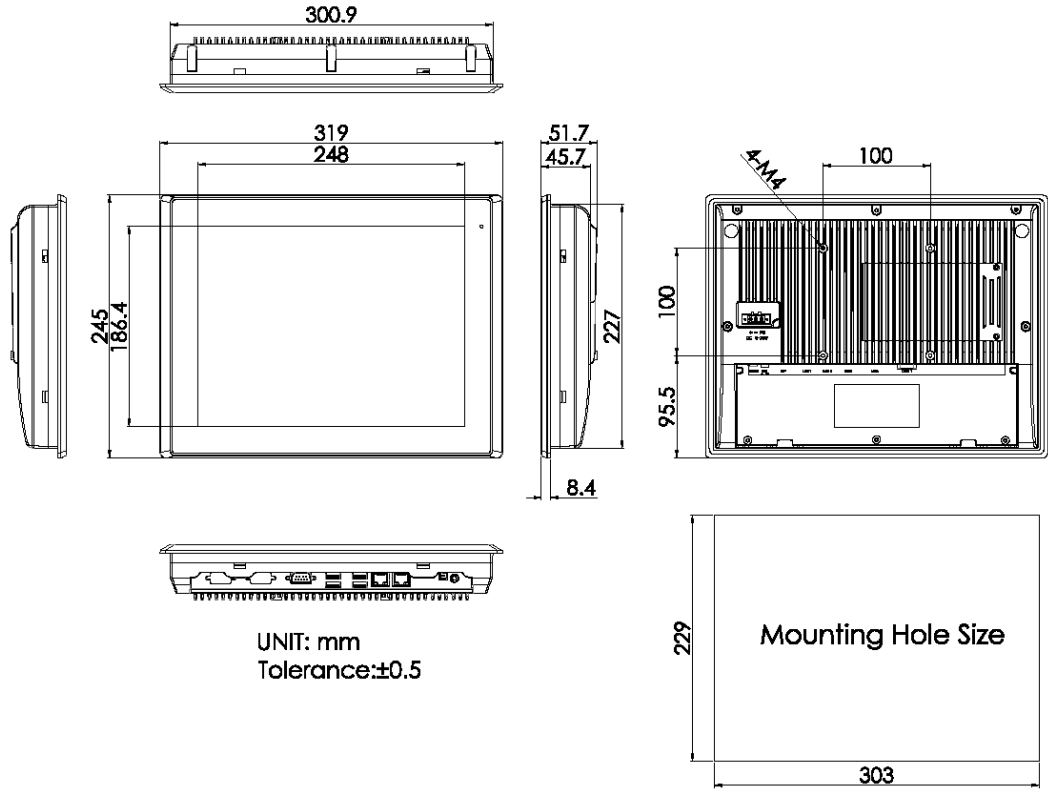

Figure 1 Dimensions of ARCHMI-912BP/BR (H)

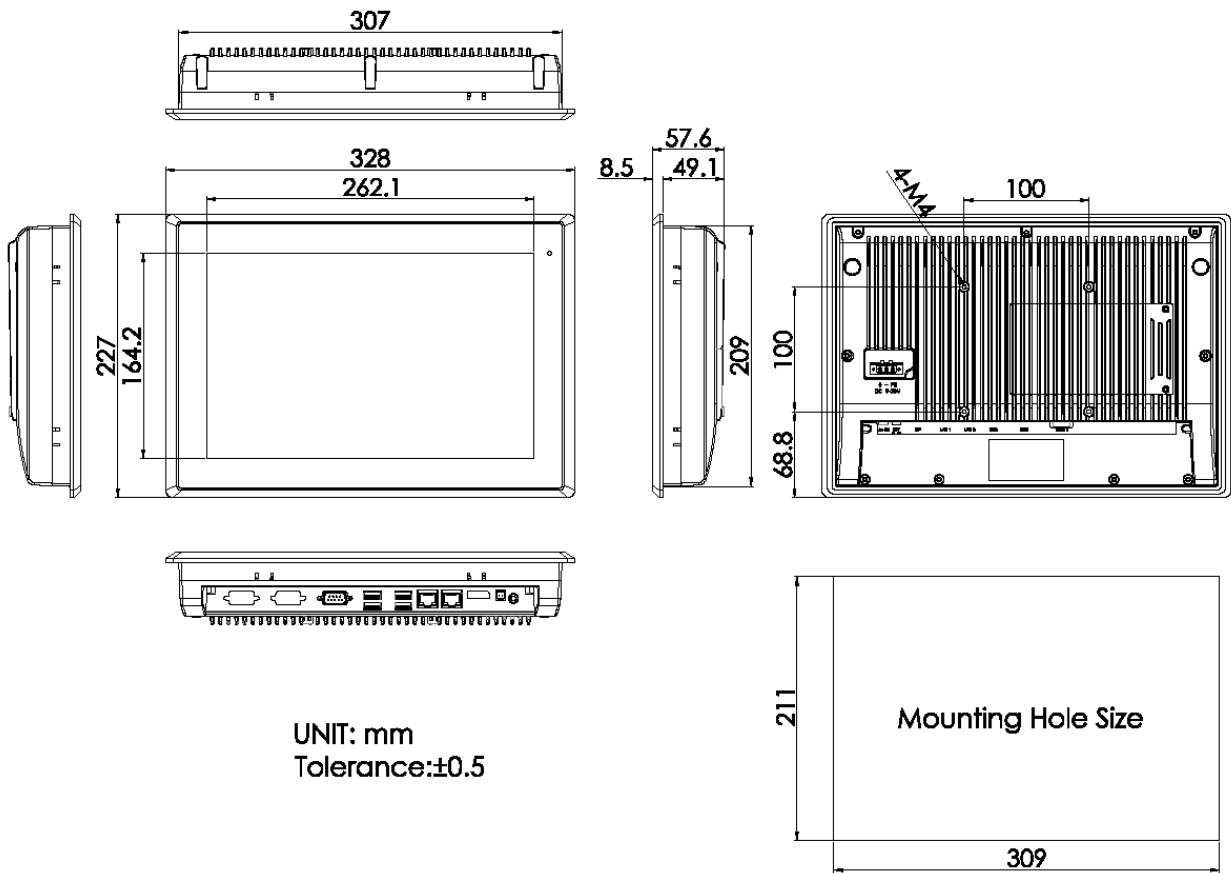

Figure 2 Dimensions of ARCHMI-912WBP/WBR (H)

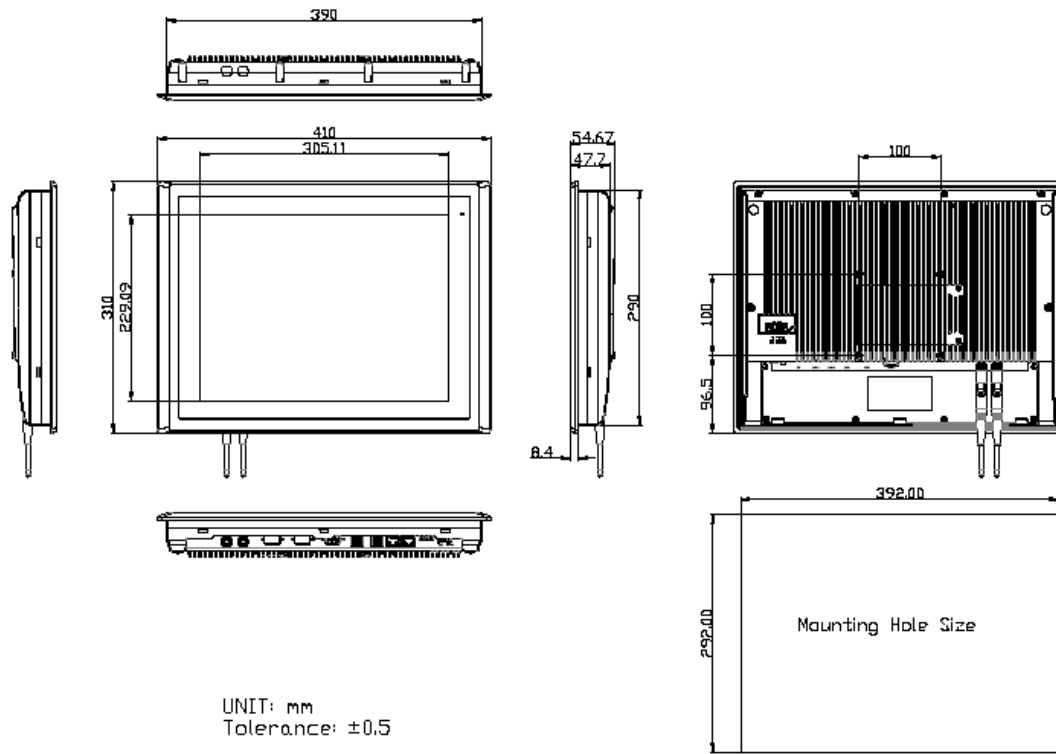

Figure 3 Dimensions of ARCHMI-915BP/BR (H)

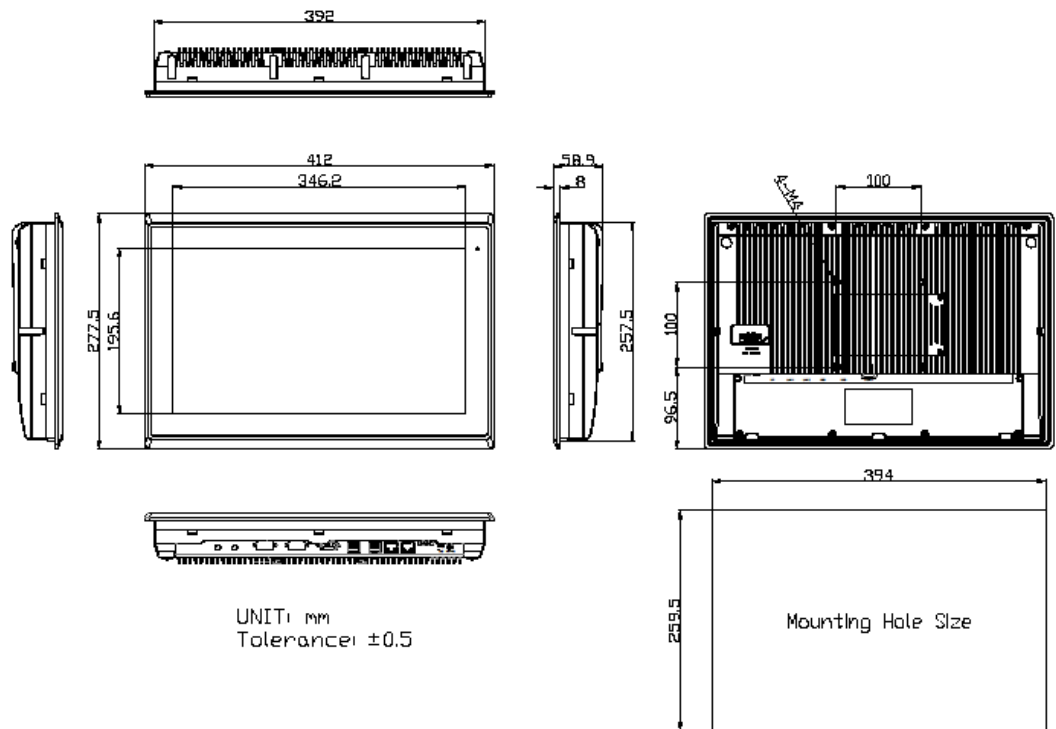

Figure 4 Dimensions of ARCHMI-916BP/BR (H)

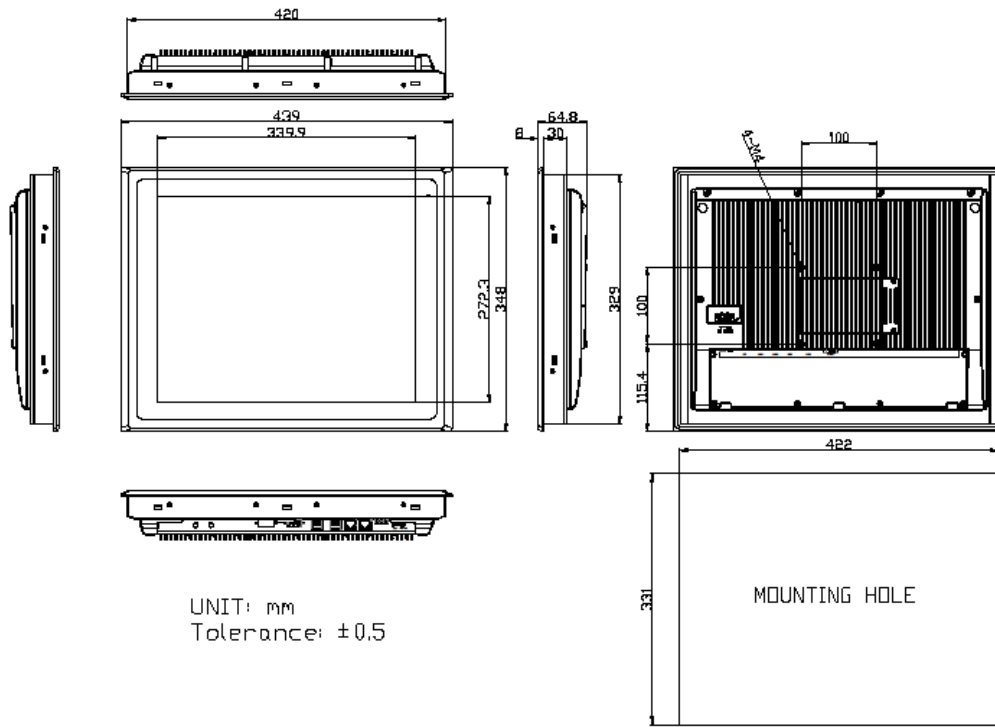

Figure 5 Dimensions of ARCHMI-917BP/BR (H)

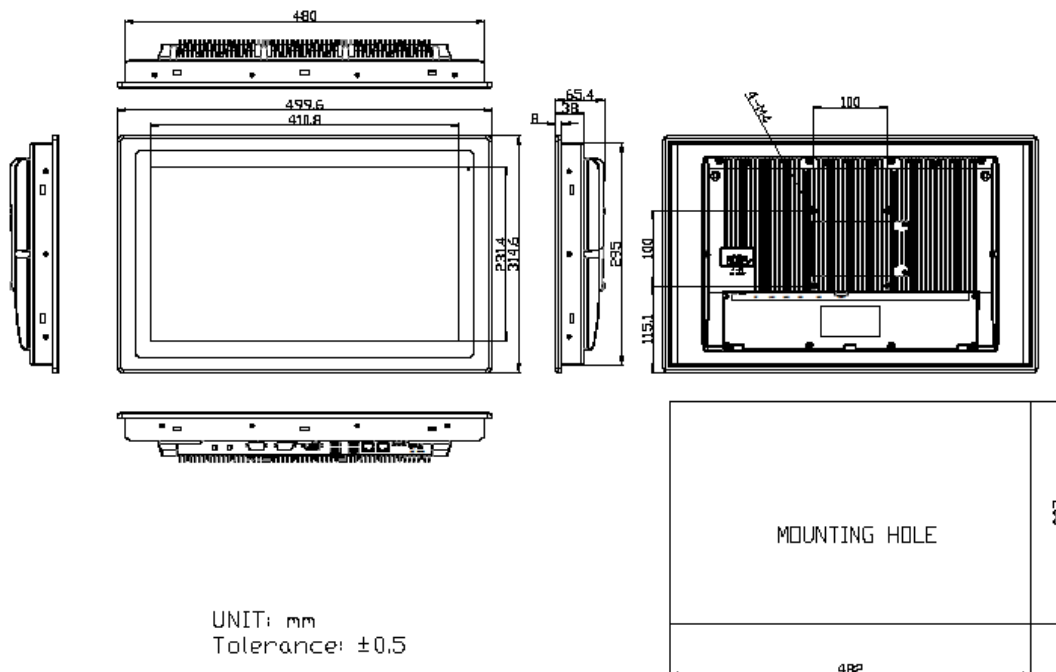

Figure 6 Dimensions of ARCHMI-918BP/BR (H)

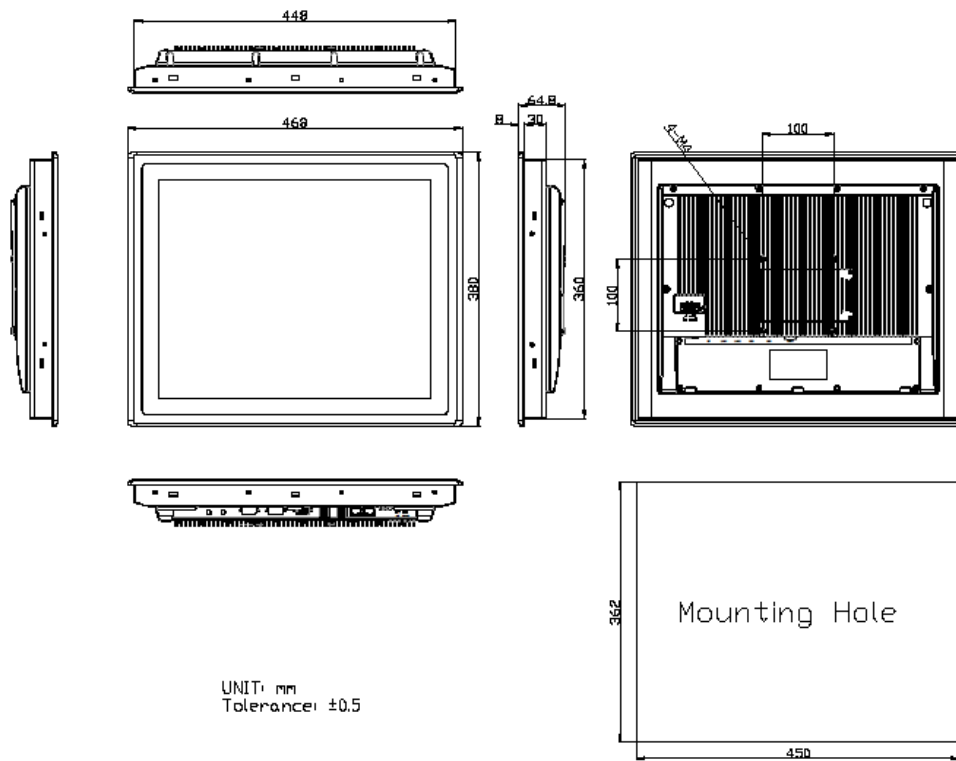

Figure 7 Dimensions of ARCHMI-919BP/BR (H)

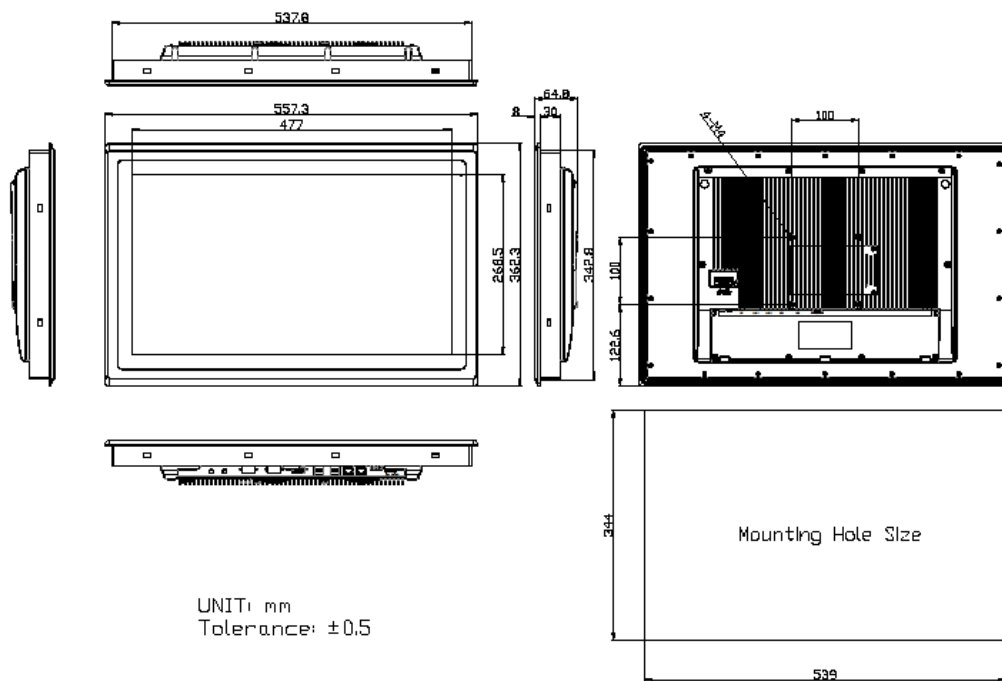

Figure 8 Dimensions of ARCHMI-921BP/BR (H)

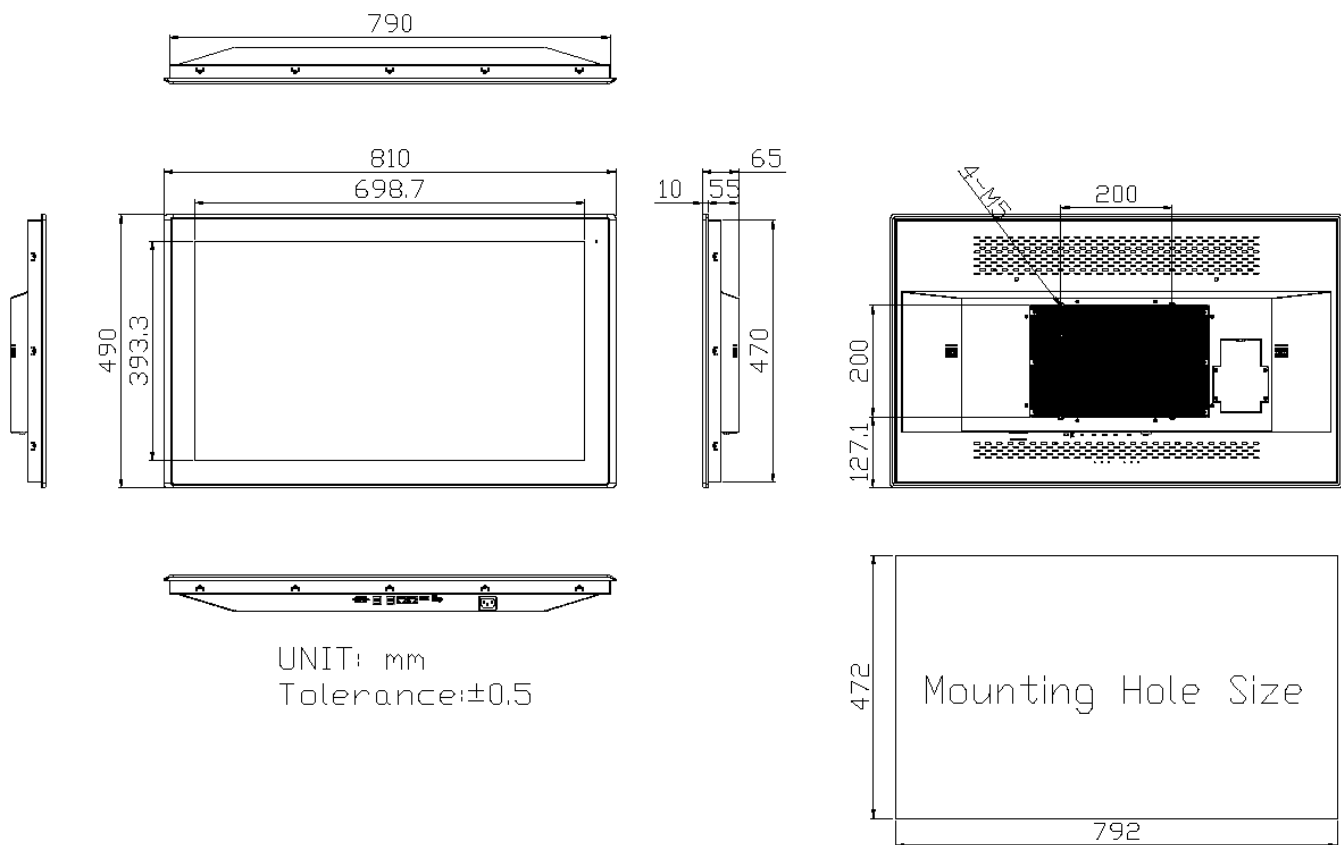

Figure 9 Dimensions of ARCHMI-932BP

1.8 Brief Description of ARCHMI-9XXB Series

There are 12.1" ~ 32" Industrial Compact Size Panel PC in ARCHMI-9XXB series, which comes with flat front panel touch screen and fanless design. It is powered by Intel 8th Generation Core i3/i5(option) CPU Processors with one SO-DIMM DDR4 slot, up to 32GB 2400 MHz. These systems support DC 9~36V wide-ranging power input and IP66 compliant front panel. Optional projected capacitive touch support 7H anti-scratch surface is ideal for use as PC-based controller for Industrial Automation & Factory Automation. Furthermore, ARCHMI-9xxB Series are capable of expanding the function by option expansion I/O boards, TB-528 series, includes Mini-PCIe, CAN bus, POE, USB, and isolation I/O module to improve competitive advantage through providing critical flexibility and expansibility for the variety of application and requirement.

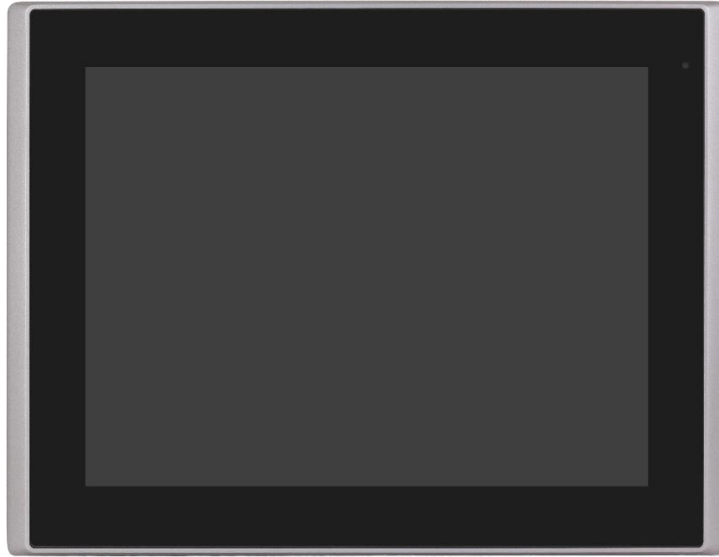

Figure 10 Front View of ARCHMI-912BP/R(H)



Figure 11 Rear View of ARCHMI-912BP/R(H)



Figure 12 Front View of ARCHMI-915BP/R(H)



Figure 13 Rear View of ARCHMI-915BP/R(H)



Figure 14 Front View of ARCHMI-916BP/R(H)



Figure 15 Rear View of ARCHMI-916BP/R(H)



Figure 16 Front View of ARCHMI-917BP/R(H)



Figure 17 Rear View of ARCHMI-917BP/R(H)

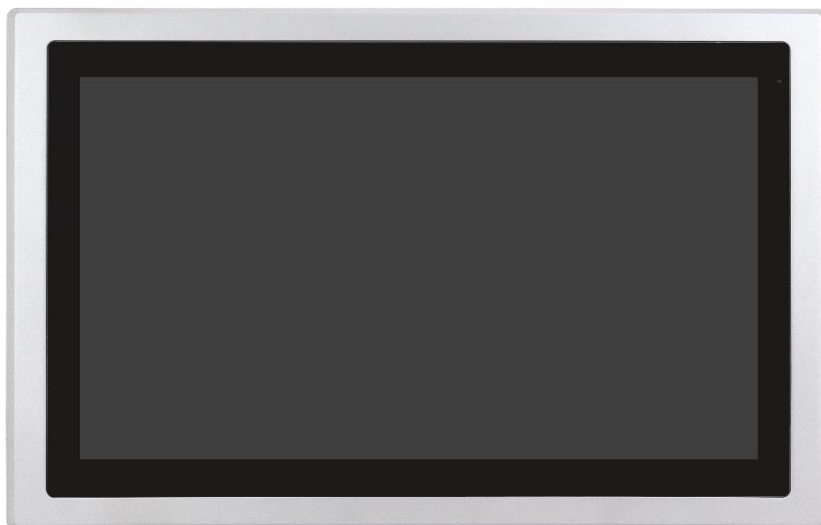

Figure 18 Front View of ARCHMI-918BP/R(H)



Figure 19 Rear View of ARCHMI-918BP/R(H)



Figure 20 Front View of ARCHMI-919BP/R(H)



Figure 21 Rear View of ARCHMI-919BP/R(H)



Figure 22 Front View of ARCHMI-921BP/R(H)



Figure 23 Rear View of ARCHMI-921BP/R(H)

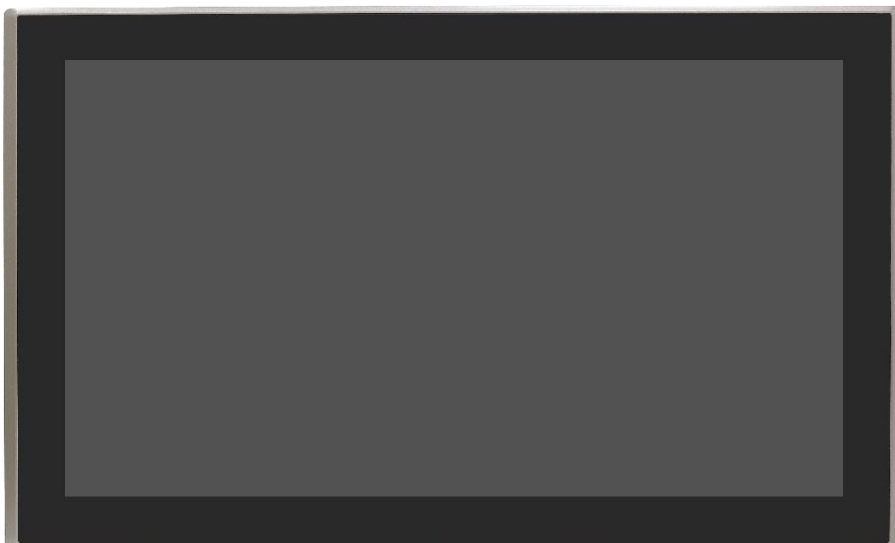

Figure 24 Front View of ARCHMI-932BP

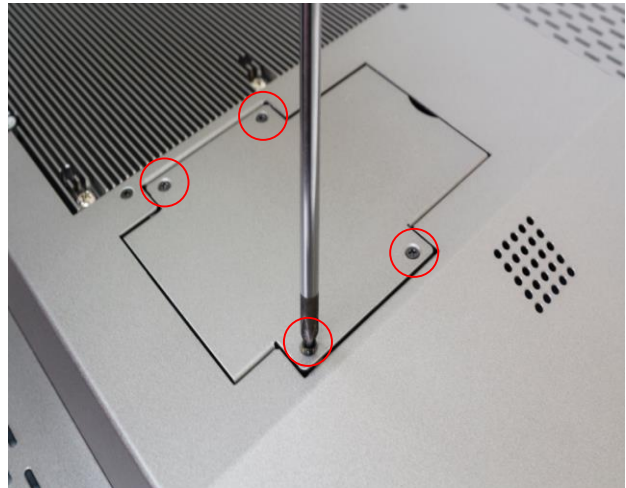

Figure 25 Rear View of ARCHMI-932BP

1.9 Installation of HDD for 32"

Step 1

There are 4 screws to deal with when enclosing or removing the chassis. Gently remove 4 screws.



Step 2

You can put or remove HDD into the machine by pulling the HDD bracket.



Step 3

You can remove HDD by unscrewing 4 screws in the HDD bracket.
Note: 4 screws are packed in the packing package.



1.10 VESA Mounting

The ARCHMI-9xxB series is designed to be VESA mounted as shown in Picture. Just carefully place the unit through the hole and tighten the given screws from the rear to secure the mounting.

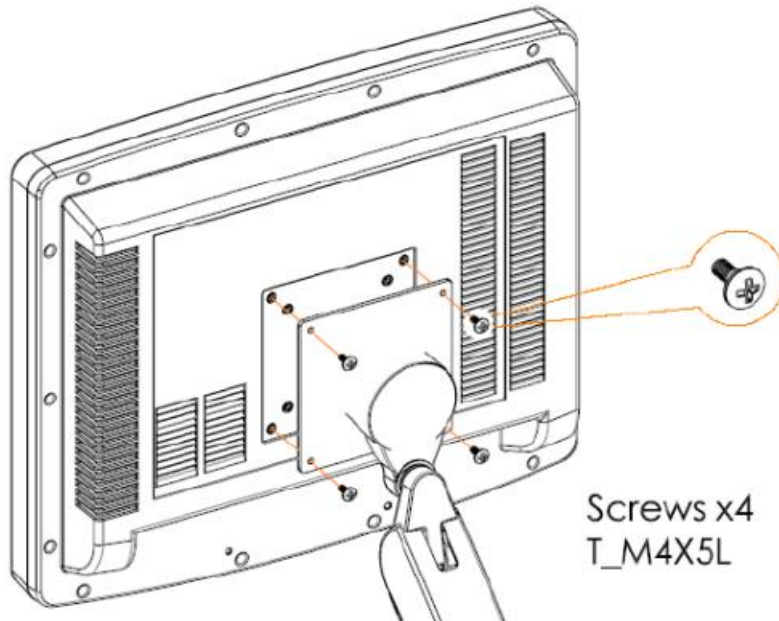

Figure 26 ARCHMI-9xxB Series VESA Mounting

1.11 Panel Mounting

There are four holes located along the four sides of the HMI. Insert the clamp from the four sides and tighten them with the nuts provided.

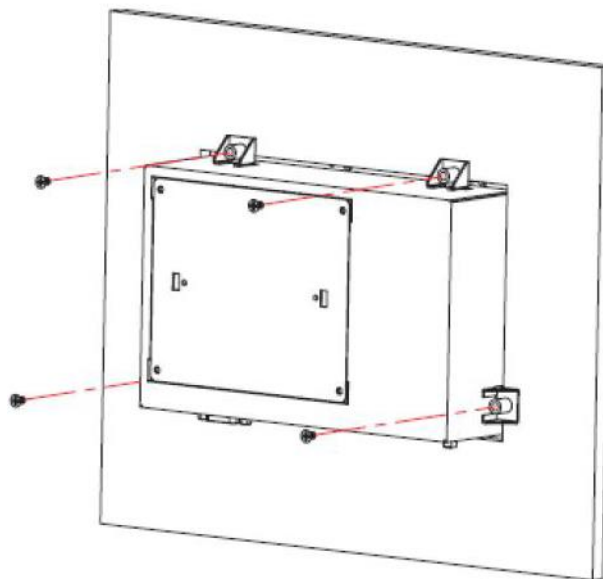

Figure 27 ARCHMI-9xxB Series Panel Mounting

SBC-7124 is a 4" industrial motherboard developed on the basis of Intel Whiskey Lake-U Processor, which provides abundant peripheral interfaces to meet the needs of different customers. Also, it features dual GbE ports, 6-COM ports and one M.2 M-Key configuration, one DP port, one LVDS interface. To satisfy the special needs of high-end customers, CN1 and CN2 and CN3 richer extension functions. The product is widely used in various sectors of industrial control.

2.1 Specifications

Specifications	
Board Size	170mm x 113mm
CPU Support	Intel® Core™ i3-8145UE/2.20 up to 3.90GHz Intel® Core™ i5-8365UE/1.60 up to 4.10GHz (option) Intel® Core™ i7-8665UE/1.70 up to 4.40GHz (option) Intel® Celeron 4305UE/2.00 GHz (option)
Chipset	SOC
Memory Support	1x SO-DIMM (260pins) up to 32GB DDR4 2133MHz FSB(4305UE) up to 32GB DDR4 2400MHz FSB(i38145UE/i58365UE/i78665UE)
Graphics	Intel® UHD Graphics 610 (4305UE) Intel® UHD Graphics 620 (i3-8145UE/i5-8365UE/i7-8665UE)
Display Mode	1 x LVDS (18/24-bit dual LVDS) 1 x DP Port
Support Resolution	Up to 4096 x 2304 for DP1 Up to 1920 x 1200 for LVDS (PS8625)
Dual Display	LVDS + DP1
Super I/O	Nuvoton NCT6106D
BIOS	AMI/UEFI
Storage	1 x SATAIII Connector (7Pin) 1 x M.2 M-Key(PCle x4/SATAIII Auto Detect),Support 2242 NVME SSD
Ethernet	1 x PCIe GbE LAN by Intel I219-LM (LAN1) 1 x PCIe GbE LAN by Intel I210-AT (LAN2)
USB	4 x USB 3.2 Gen1 (Type A) Stack ports (USB3_1/USB3_2)

	<p>(USB3.2:USB3-1/USB3-2/USB3_3/USB3_4,USB2.0:USB1/2/3/4)</p> <p>2 x USB 2.0 Pin header for CN3 (USB5/USB6)</p> <p>1 x USB 2.0 Pin header for CN1 (USB7)</p> <p>1 x USB 2.0 Pin header for CN2 (USB8)</p> <p>1 x USB 2.0 for M-PCIE1 (USB9)</p> <p>1 x USB 2.0 for PM6000 (USB10)</p>
Serial	<p>1 x DB9-M Connector for external (COM1)</p> <p>1x RS232 port, Pin1 w/5V/12V/RTS select (COM1-1)</p> <p>1x RS232/RS422/RS485 port (COM1-2)</p> <p>2 x UART for CN3 (COM3,COM4)</p> <p>2 x RS422/485 header for CN2 (COM5/COM6)</p>
Digital I/O	<p>8-bit digital I/O by Pin header (CN2)</p> <p>4-bit digital Input</p> <p>4-bit digital Output</p> <p>4-bit digital I/O by Pin header (CN3)</p> <p>2-bit digital Input</p> <p>2-bit digital Output</p>
Battery	Support CR2477 Li battery by 2-pin header
Smart battery	<p>1 x Smart battery</p> <p>Support 3 Serial Li battery by 10-pin header (BAT2)</p>
Audio	<p>Support Audio via Realtek ALC888S-VD2 audio codec</p> <p>Support Line-out by JACK (LINE_OUT1)</p> <p>Support Line-in, Line-out, MIC by 2x6-pin header (F_AUDIO1)</p>
Expansion Bus	<p>1 x mini-PCI-express slot for M-PCIE1</p> <p>1 x PCI-express for CN3</p>
Touch Ctrl	1 x Touch ctrl header for TCH1 (USB10)
Power Management	<p>Wide Range DC9V~36V input</p> <p>1 x 3-pin power input connector</p>
Switches and LED Indicators	<p>1 x Power on/off switch (BT1/CN2/CN3)</p> <p>1 x Reset (CN2)</p> <p>1 x HDD LED status (CN2)</p> <p>1 x Power LED status (CN1)</p> <p>1 x Buzzer</p>
External I/O port	<p>1 x COM Ports (COM1-1/COM1-2)</p> <p>4 x USB 3.2 Gen1 Ports (stack)</p> <p>2 x RJ45 GbE LAN Ports</p>

	1 x DP Port 1 x Audio Jack (Line out)
TPM	Infineon's Trusted Platform Module (TPM 2.0) *Note: Only support Windows 10 IOT
Temperature	Operating: -20°C to 70°C Storage: -40°C to 85°C
Humidity	10% - 90%, non-condensing, operating
Power Consumption	24V/1.6A (Intel i3-8145UE Processor with 16GB DDR4/HDD) 24V/2.0A (Intel i5-8365UE Processor with 16GB DDR4/HDD)
EMI/EMS	Meet CE/FCC class A

2.2 Board Dimensions

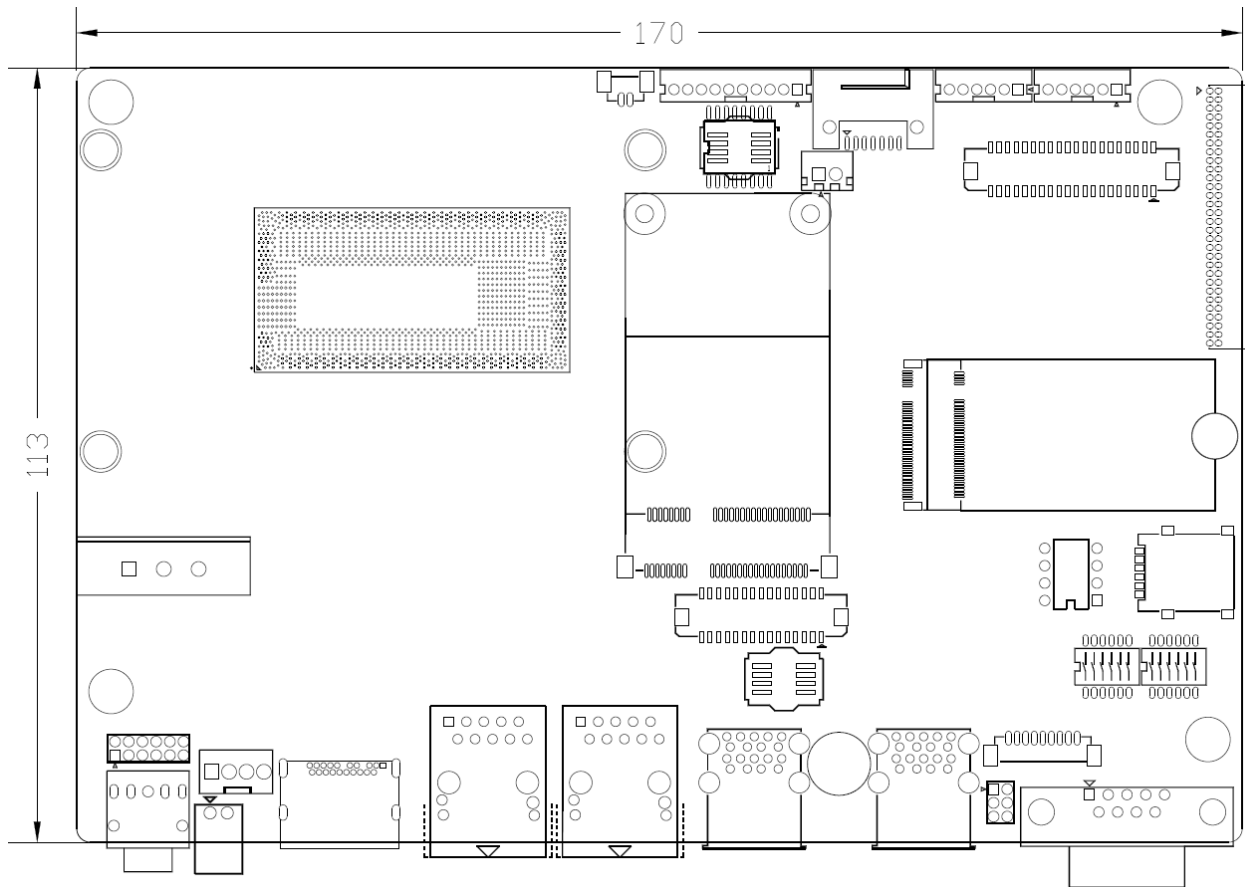

(units :mm)

2.3 Jumpers and Connectors Location

Board Top

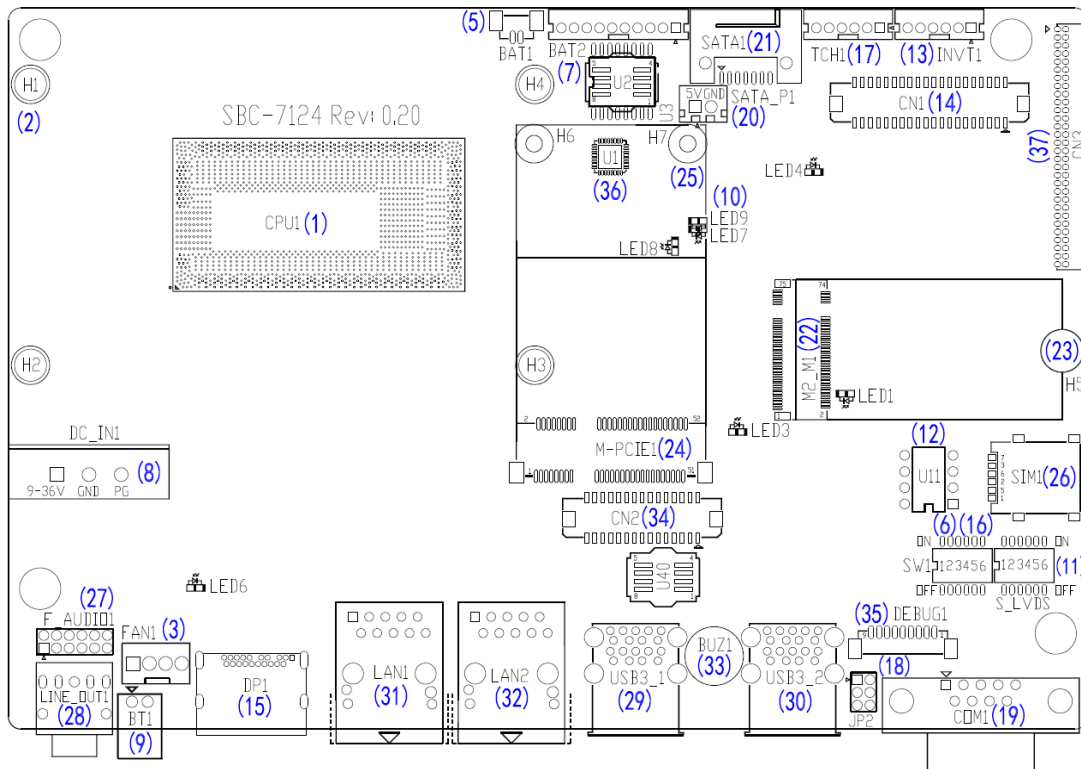

Board Bottom

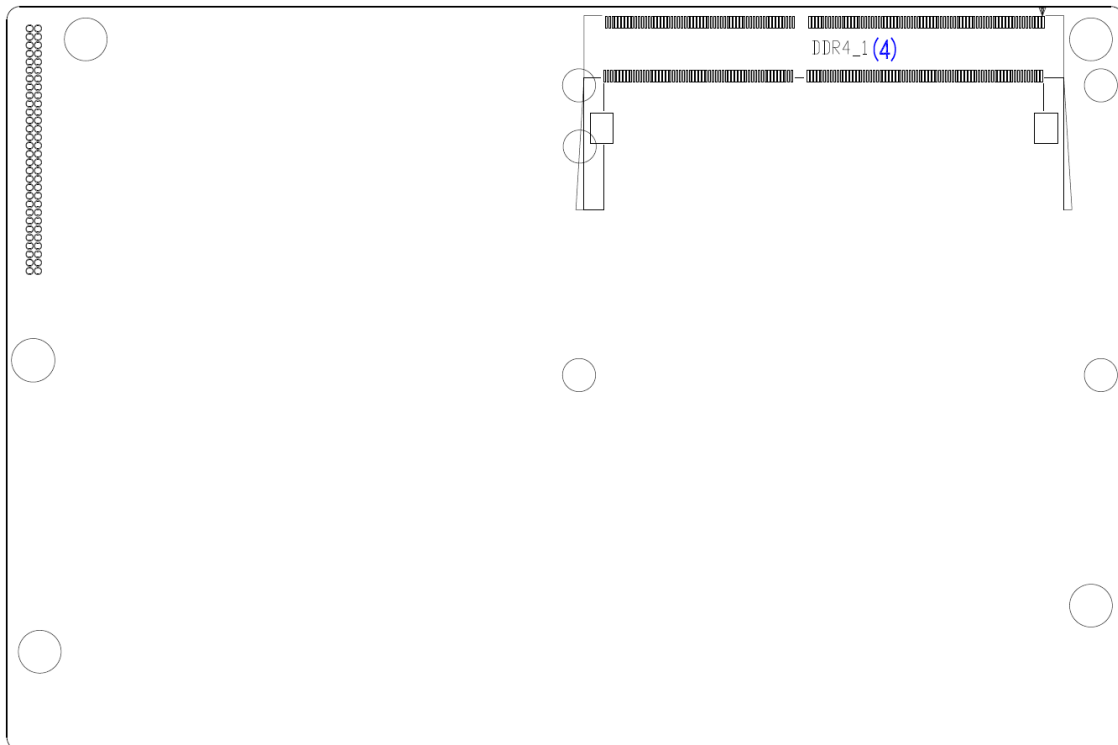

2.4 Jumpers Setting and Connectors

1. CPU1:

(FCBGA1528), onboard Intel Whiskey Lake-UE Processors.

Model	Processor						
	Number	PBF	Cores/ Threads	TDP	Embedded	Intel VPro	Remarks
SBC-7124-I3-8145UE	I3-8145UE	2.20 up to 3.90GHz	2/4	12.5W 25W	●	○	
SBC-7124-I5-8365UE	I5-8365UE	1.60 up to 4.10GHz	4/8	12.5W 25W	●	●	option
SBC-7124-I7-8665UE	I7-8665UE	1.70 up to 4.40GHz	4/8	12.5W 25W	●	●	option
SBC-7124-4305UE	Celeron 4305UE	2.0GHz	2 / 2	15W	●	○	option

2. H1/H2/H3/H4(option):

CPU1 Heat Sink Screw holes, four screw holes for intel Whiskey Lake-UE Processors. Heat Sink assemblies.

3. FAN1:

(2.54mm Pitch 1x4 Pin Header), FAN connector, cooling fans can be connected directly for use. You may set the rotation condition of cooling fan in menu of BIOS CMOS Setup.

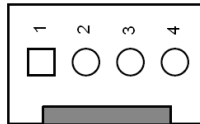

Pin#	Signal Name
1	Ground
2	VCC
3	SYS_FANTACH
4	SYS_FANPWM



Note:

Output power of cooling fan must be limited under 5W.

4. DDR4_1:

(SO-DIMM 260Pin slot), DDR4 memory socket, the slot is located at the socket of the board and supports 260Pin 1.2V DDR4 2133/2400MHz FSB SO-DIMM memory module up to 32GB.

Model	DDR4 Memory Types (FSB)
SBC-7124-I3-8145UE	2400 MHz
SBC-7124-I5-8365UE	2400 MHz

SBC-7124-I7-8665UE	2400 MHz
SBC-7124-4305UE	2133 MHz

5. **BAT1 :**

(1.25mm Pitch 1x2 Wafer Pin Header, SMD) 3.0V Li battery is embedded to provide power for CMOS. CMOS clear operation will permanently reset old BIOS settings to factory defaults.

Pin#	Signal Name
Pin1	Ground
PIN2	VBAT

6. **SW1(PIN1,PIN2,PIN3,PIN6):**

SW1-6(Switch),ATX Power and Auto Power on jumper setting.

SW1(Switch)	Mode
Pin6 (Off)	ATX Power
Pin6 (On)	Auto Power on (Default)

SW1-1(Switch),POE or DCIN input setting.

SW1(Switch)	DC_IN1	BAT2(PoE)
Pin1 (off,Default)	●	-
Pin1 (On)	-	●

SW1-2, SW1-3 (Switch),CMOS clear switch, CMOS clear operation will permanently reset old BIOS settings to factory defaults.

SW1	CMOS
Pin2 OFF	NORMAL (Default)
Pin2 ON	Clear CMOS
Pin3 OFF	NORMAL (Default)
Pin3 ON	Clear CMOS



Procedures of CMOS clear:

- Turn off the system and unplug the power cord from the power outlet.
- To clear the CMOS settings, use the switch to Pin2 on for about 3 seconds then move the switch Pin2 and Pin3 off.
- Power on the system again.
- When entering the POST screen, press the key to enter CMOS Setup

Utility to load optimal defaults.

e) After the above operations, save changes and exit BIOS Setup.

7. **BAT2:**

(2.0mm Pitch 1x10 Wafer Pin Header), Smart battery Interface.

Pin#	Signal Name
Pin1	VCC_BAT1
Pin2	VCC_BAT1
Pin3	VCC_BAT1
Pin4	SMB_DAT_SW
Pin5	SMB_CLK_SW
Pin6	BAT1_TEMP
Pin7	Ground
Pin8	Ground
Pin9	Ground
Pin10	NC

Function	Specifications
Nominal voltage (3S1P)	11.1~12.6V
Charge voltage	12.6V
Charge current	0.5C

8. **DC_IN1:**

(5.08mm Pitch 1x3 Pin Connector), DC9V~36V System power input connector.

Pin#	Power Input
Pin1	DC_IN+ (DC+9V~36V)
Pin2	DC_IN- (Ground)
Pin3	FG

Model	DC_IN1
SBC-7124-I3-8145UE	180°Connector
SBC-7124-I5-8365UE	180°Connector
SBC-7124-I7-8665UE	180°Connector
SBC-7124-4305UE	180°Connector

Connector	Power input
DC_IN1 (Default)	DC_IN1
BAT2 (option)	BAT2
DC_IN1 + BAT2 (option)	DC_IN1

9. BT1 :

Power on/off button, They are used to connect power switch button. The two pins are disconnected under normal condition. You may short them temporarily to realize system startup & shutdown or awaken the system from sleep state.

10. LED1/LED2/LED3/LED4/LED5/LED6/LED7/LED8/LED9:

LED1: LED STATUS. Green LED for M2_M1 Power status.

LED2: LED STATUS. Green LED for PM6000 Power status.

LED3: LED STATUS. Green LED for 3P3V_ALLS_EC Power status.

LED4: LED STATUS. Green LED for PM_S5_OK status.

LED5: LED STATUS. Green LED for PM_PCH_PWROK status.

LED6: LED STATUS. Green LED for H_CATERR status.

LED7: LED STATUS. Green LED for charge Power Good status.

LED8: LED STATUS. Green LED for charge Power Good status.

LED9: LED STATUS. Green LED for charge Complete status.

11. S_LVDS:

(Switch), LVDS jumper setting.

S_LVDS(Switch)	Function (CN1)
Pin1 (ON)	3.3V Level
Pin1 (OFF)	5V Level
Pin2 (ON)	Single channel LVDS
Pin2 (OFF)	Dual channel LVDS
Pin3 (ON)	8/24 bit
Pin3 (OFF)	6/18 bit
Pin4 (ON)	DC Mode
Pin4 (OFF)	PWM Mode
Pin5 (ON)	Enable PS8625
Pin5 (OFF)	Disable PS8625

12. U11:

AT24C02-DIP8, The EEPROM IC (U11) is the set of LVDS resolution.

If you need other resolution settings, please upgrade U11 data.

Model	LVDS resolution
SBC-7124-I3-8145UE	1280*1024 (Default)
SBC-7124-I5-8365UE	800*480 (option)
SBC-7124-I7-8665UE	800*600 (option)
SBC-7124-4305UE	1024*768 (option)

	1920*1080 (option)

13. INVT1:

(2.0mm Pitch 1x6 wafer Pin Header), Backlight control connector for LVDS.

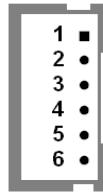

Pin#	Signal Name
1	+DC12V_LVDS
2	+DC12V_LVDS
3	Ground
4	Ground
5	BKLT_EN_OUT
6	BKLT_PWM_OUT

14. CN1:

(1.25mm Pitch 2x20 Connector, DF13-40P), For 18/24-bit LVDS output connector, Fully supported by Parad PS8625 (DP to LVDS), the interface features dual channel 24-bit output. Low Voltage Differential Signaling, A high speed, low power data transmission standard used for display connections to LCD panels.

Function	Signal Name	Pin#	Signal Name	Function
LVDS Signal	12V_LVDS	2	1	12V_LVDS
	BKLT_EN_OUT	4	3	BKLT_CTRL
	Ground	6	5	Ground
	LVDS_VDD5	8	7	LVDS_VDD 5
	LVDS_VDD3	10	9	LVDS_VDD 3
	Ground	12	11	Ground
	LA_D0_P	14	13	LA_D0_N
	LA_D1_P	16	15	LA_D1_N
	LA_D2_P	18	17	LA_D2_N
	LA_D3_P	20	19	LA_D3_N
	LA_CLKP	22	21	LA_CLKN
	LB_D0_P	24	23	LB_D0_N
LB_D1_P	26	25	LB_D1_N	

	LB_D2_P	28	27	LB_D2_N	
	LB_D3_P	30	29	LB_D3_N	
	LB_CLKP	32	31	LB_CLKN	
USB7 (option)	Ground	34	33	Ground	
	USB7_P	36	35	USB7_N	
	5V_S5_USB	38	37	5V_S5	
Power LED	PWR_LED+	40	39	Ground	

15. DP1:

(DP Connector), Display Port Interface connector.

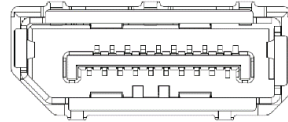

16. SW1(PIN5):

SW1-5(Switch), Touch jumper setting.

SW1(Switch)	Touch (TCH1)
SW1-5 OFF (Default)	Enable
SW1-5 ON (option)	Disable

17. TCH1:

(2.0mm Pitch 1x6 wafer Pin Header), internal Touch controller connector.

Pin#	Signal Name
1	SENSE
2	X+
3	X-
4	Y+
5	Y-
6	GND_EARCH

18. JP2:

(2.0mm Pitch 2x3 Pin Header), COM1 jumper setting, pin 1~6 are used to select signal out of pin 1 of COM1 port.

JP1 Pin#	Function
Close 1-2	COM1 Pin1 RTS (Default)
Close 3-4	COM1 Pin1: DC+5V (option)
Close 5-6	COM1 Pin1: DC+12V (option)

***Warning: 5V/12V located in Pin 1 of COM 1. If you plug the device in different pin, it may damage the devices**

19. COM1:

(Type DB9M), Rear serial port, standard DB9 Male serial port is provided to make a direct connection to serial devices. COM1 port is controlled by pins No.1~6 of JP2, select output Signal RTS or 5V or 12V, For details, please refer to description of JP2 setting.

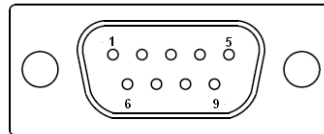

Pin#	COM1 (RS232)	COM2 (RS232)	COM2 (RS422)	COM2 (RS485)
1	RTS-/5V/12V	-	-	-
2	RXD1	-	-	-
3	TXD1	-	-	-
4	CTS1-	-	-	-
5	Ground	Ground	Ground	Ground
6	-	TXD2	422_RX+	-
7	-	DTR2-	422_RX-	-
8	-	DCD2-	422_TX-	485-
9	-	RXD	422_TX+	485+

COM1 BIOS Setup :

Advanced/NCT6106D Super IO Configuration/Serial Port 1 Configuration: **【RS-232】**

COM2 BIOS Setup :

Advanced/NCT6106D Super IO Configuration/Serial Port 1 Configuration: **【RS-232】**

Advanced/NCT6106D Super IO Configuration/Serial Port 1 Configuration: **【RS-422】**

Advanced/NCT6106D Super IO Configuration/Serial Port 1 Configuration: **【RS-485】**

20. SATA_P1:

(2.5mm Pitch 1x2 box Pin Header), One onboard 5V output connector are reserved to provide power for SATA devices.

Pin#	Signal Name
1	5V_S0 (+DC5V output)
2	Ground



Note:

Output current of the connector must not be above 1A.

21. SATA1:

(SATA 7Pin), SATA Connectors, one SATA connector are provided, with transfer speed up to 6.0Gb/s.

22. M2_M1:

(NGFF M.2 Socket),NGFF(M.2) M-Key, it is located at the top, it supports M.2 M-Key devices with four PCIe or SATA signal. support 2242 size card.

23. H5:

M2_M1 SCREW HOLES, H5 for M2_M1 card assemble.

24. M-PCIE1:

(Socket 52Pin),mini PCIe socket, it is located at the top, it supports mini PCIe devices with USB2.0 and SIM and SMBUS signal. MPCie card size is 30x50.95mm.

Function	Support	Remarks
Mini PCIe (PCIe 13)	●	
SMbus	●	
SIM	●	
USB2.0 (USB9)	●	

25. H7:

M-PCIE1 SCREW HOLES, H7 for mini PCIE card (30mmx50.95mm) assemble.

26. SIM1:

(NANO-SIM Socket), Support nano SIM Card devices.

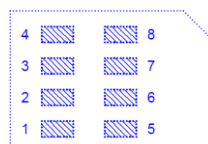

27. F_AUDIO1:

(2.0mm Pitch 2X6 Pin Header), Front Audio, An onboard Realtek ALC888S-VD2 codec is used to provide high-quality audio I/O ports. Line Out can be connected to a headphone or amplifier. Line In is used for the connection of external audio source via a Line in cable. MIC is the port for microphone input audio.

Signal Name	Pin#	Pin#	Signal Name
+5V_F_AUDIO	1	2	GND_AUD
LINE-OUT-L	3	4	LINE-OUT-R
FRONT_JD	5	6	LINE_IN_JD
LINE-IN-L	7	8	LINE-IN-R
MIC-IN-L	9	10	MIC-IN-R
GND_AUD	11	12	MIC1_JD

28. LINE_OUT1:

(Diameter 3.5mm Jack), HD Audio port, An onboard Realtek ALC888S-VD2 codec is used to provide high quality audio I/O ports. Line Out can be connected to a headphone or amplifier.

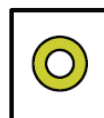

Line out

29. USB3_1:

USB3-1/USB3-2 : (Double stack USB type A), Rear USB connector, it provides up to two USB3.2 Gen1 ports, High-speed USB 2.0 allows data transfers up to 480 Mb/s, USB 3.2 Gen1 allows data transfers up to 5.0Gb/s, support USB full-speed and low-speed signaling.

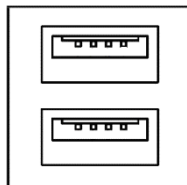

Each USB Type A Receptacle (2 Ports) Current limited value is 2.0A.

If the external USB device current exceeds 1.5A, please separate connectors into different Receptacle.

30. USB3_2:

USB3-3/USB3-4 : (Double stack USB type A), Rear USB connector, it provides up to two USB3.2 Gen1 ports, High-speed USB 2.0 allows data transfers up to 480 Mb/s, USB 3.2 Gen1 allows data transfers up to 5.0Gb/s, support USB full-speed and low-speed signaling.

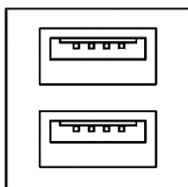

Each USB Type A Receptacle (2 Ports) Current limited value is 2.0A.
If the external USB device current exceeds 1.5A, please separate connectors into different Receptacle.

31. LAN1:

(RJ45 Connector), Rear LAN port, Two standard 10/100/1000M RJ-45 Ethernet ports are provided. Used intel I219-LM chipset, LINK LED (green) and ACTIVE LED (green or orange) respectively located at the left-hand and right-hand side of the Ethernet port indicate the activity and transmission state of LAN. Corporate LAN product with support for Intel® AMT2 technology.

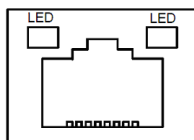

32. LAN2:

(RJ45 Connector), Rear LAN port, Two standard 10/100/1000M RJ-45 Ethernet ports are provided. Used intel I210-AT chipset, LINK LED (green) and ACTIVE LED (green or orange) respectively located at the left-hand and right-hand side of the Ethernet port indicate the activity and transmission state of LAN.

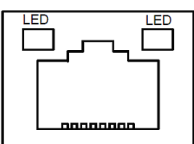

33. BUZ1:

Onboard buzzer.

34. CN2:

(DF13-30P Connector), For expand output connector, It provides eight GPIO, two RS422 or RS485, one USB2.0, one Power on/off, one Reset.

Function	Signal Name	Pin#		Signal Name	Function
5V	5V_S5	2	1	5V_S5	5V
SIO_GP31	GPIO_IN2	4	3	GPIO_IN1	SIO_GP30

SIO_GP33	GPIO_IN4	6	5	GPIO_IN3	SIO_GP32
SIO_GP35	GPIO_OUT2	8	7	GPIO_OUT 1	SIO_GP34
SIO_GP37	GPIO_OUT4	10	9	GPIO_OUT 3	SIO_GP36
	Ground	12	11	Ground	
485 or 422 (COM5)	485+_422TX5+	14	13	485-_422TX5-	485 or 422 (COM5)
	422_RX5+	16	15	422_RX5-	
485 or 422 (COM6)	485+_422TX6+	18	17	485-_422TX6-	485 or 422 (COM6)
	422_RX6+	20	19	422_RX6-	
5V	5V_S0	22	21	HDD_LED+	HDD LED
USB2.0	5V_S5	24	23	5V_S5	USB2.0
	USB8_P	26	25	USB8_N	
	Ground	28	27	FP_RST-	RESET
Power auto on	PWRBTN_O N	30	29	Ground	
<p>COM5 BIOS Setup :</p> <p>Advanced/NCT6106D Super IO Configuration/Serial Port 5 Configuration: 【RS-422】</p> <p>Advanced/NCT6106D Super IO Configuration/Serial Port 5 Configuration: 【RS-485】</p> <p>COM6 BIOS Setup :</p> <p>Advanced/NCT6106D Super IO Configuration/Serial Port 6 Configuration: 【RS-422】</p> <p>Advanced/NCT6106D Super IO Configuration/Serial Port 6 Configuration: 【RS-485】</p>					

35. DEBUG1(option):

(1.25mm Pitch 1x9 Wafer Pin Header, SMD), Debug Port.

Pin#	Signal Name
Pin1	3P3V_S0
Pin2	CLK_24M_SIO
Pin3	PLT_RST_BUF1-
Pin4	Ground
Pin5	LPC_AD0
Pin6	LPC_AD1
Pin7	LPC_AD2
Pin8	LPC_AD3
Pin9	LPC_FRAME-

36. U1(option):

Infineon's Trusted Platform Module (TPM 2.0) SLB9665 is a fully standard compliant TPM based on the latest Trusted Computing Group (TCG) specification 2.0.

***Note: Only support Windows 10 IOT.**

37. CN3:

(1.27mm Pitch 2x30 Female Header), For expand output connector, It provides four GPIO, two USB 2.0, one SPI, two Uart, one PClex1, one SMBus, connected to the TB-528 riser Card.

Function	Signal Name	Pin#		Signal Name	Function
	5V_S5_USB	1	2	5V_S5_USB	
	5V_S5_USB	3	4	5V_S5_USB	
	USB0506_O C	5	6	PS_ON_ALL-	
USB5	USB5_N	7	8	USB5_P	USB5
USB6	USB6_N	9	10	USB6_P	USB6
	Ground	11	12	Ground	
SPI	PCH_SPI1_CLK	13	14	SPI1_MISO_PCH	SPI
	PCH_SPI1_CS0-	15	16	PCH_SPI1_MOSI	
COM4 (UART)	COM4_RI	17	18	COM4_DCD-	COM4 (UART)
	COM4_TXD	19	20	COM4_RXD	
	COM4_DTR	21	22	COM4_RTS-	
	COM4_DSR	23	24	COM4_CTS-	
	Ground	25	26	Ground	
COM3 (UART)	COM3_RI	27	28	COM3_DCD-	COM3 (UART)
	COM3_TXD	29	30	COM3_RXD	
	COM3_DTR	31	32	COM3_RTS-	
	COM3_DSR	33	34	COM3_CTS-	
	SIO_GP45	35	36	SIO_GP44	
	SIO_GP47	37	38	SIO_GP46	
	Ground	39	40	Ground	
PCIE14	PCIE14_TX_N0	41	42	PE14_TX_P0	PCIE14
	PCIE14_RX_N0	43	44	PE14_RX_P0	
	Ground	45	46	Ground	
	CLK_100M_PE4_N	47	48	CLK_100M_PE4_P	
	PCIE_WAKE_N	49	50	PLT_RST_BUF2-	
SMBUS	SMB_CLK_S 0	51	52	SMB_DATA_S 0	SMBUS
PCIE	CLKREQ_PE 4-	53	54	Ground	
	3P3V_S5	55	56	PWRBTN_ON-	Power Auto on
	3P3V_S5	57	58	3P3V_S5	
12V	12V_S0	59	60	12V_S0	12V

3.1 Operations after POST Screen

After CMOS discharge or BIOS flashing operation. Press [Delete] key to enter CMOS Setup.



After optimizing and exiting CMOS Setup

3.2 BIOS SETUP UTILITY

Press [Delete] key to enter BIOS Setup utility during POST, and then a main menu containing system summary information will appear.

3.3 Main Settings

Aptio Setup Utility – Copyright (C) 2021 American Megatrends, Inc.					
Main	Advanced	Chipset	Security	Boot	Save & Exit
BIOS Information BIOS Vendor: American Megatrends Core Version: 5.13 Compliancy: UEFI 2.7; PI 1.6 Project Version: 7124V 1.08 x64 EC VERSION: 7124E033 Build Date and Time: 10/25/2021 17:09:16 Access Level: Administrator					Choose the system default Language
Processor Information Name: WhiskeyLake ULT Type: Intel(R) Core(TM) I5-8365UE CPU @ 1.60GHz Speed: 1800 MHz ID: 0x806EC Stepping: V0 Package: BGA1528 IGFX VBIOS Version: 1023 IGFX GOP Version: N/A Memory RC Version: 0.7.1.111 Total Memory: 4096 MB Memory Frequency: 2133 MHz					→←: Select Screen ↑↓ : Select Item Enter: Select +/- : Charge Opt. F1 : General Help F2: Previous Values F3: Optimized Defaults F4: Save and Exit ESC: Exit
System Language [English]					
System Date [Thu 01/01/2021]					
System Time [00:00:12]					
Version 2.20.1275. Copyright (C) 2021 American Megatrends , Inc.					

System Time:

Set the system time, the time format is:

Hour : 0 to 23
 Minute : 0 to 59
 Second : 0 to 59

System Date:

Set the system date, the date format is:

Day: Note that the 'Day' automatically changes when you set the date.
Month: 01 to 12
Date: 01 to 31
Year: 1998 to 2099

3.4 Advanced Settings

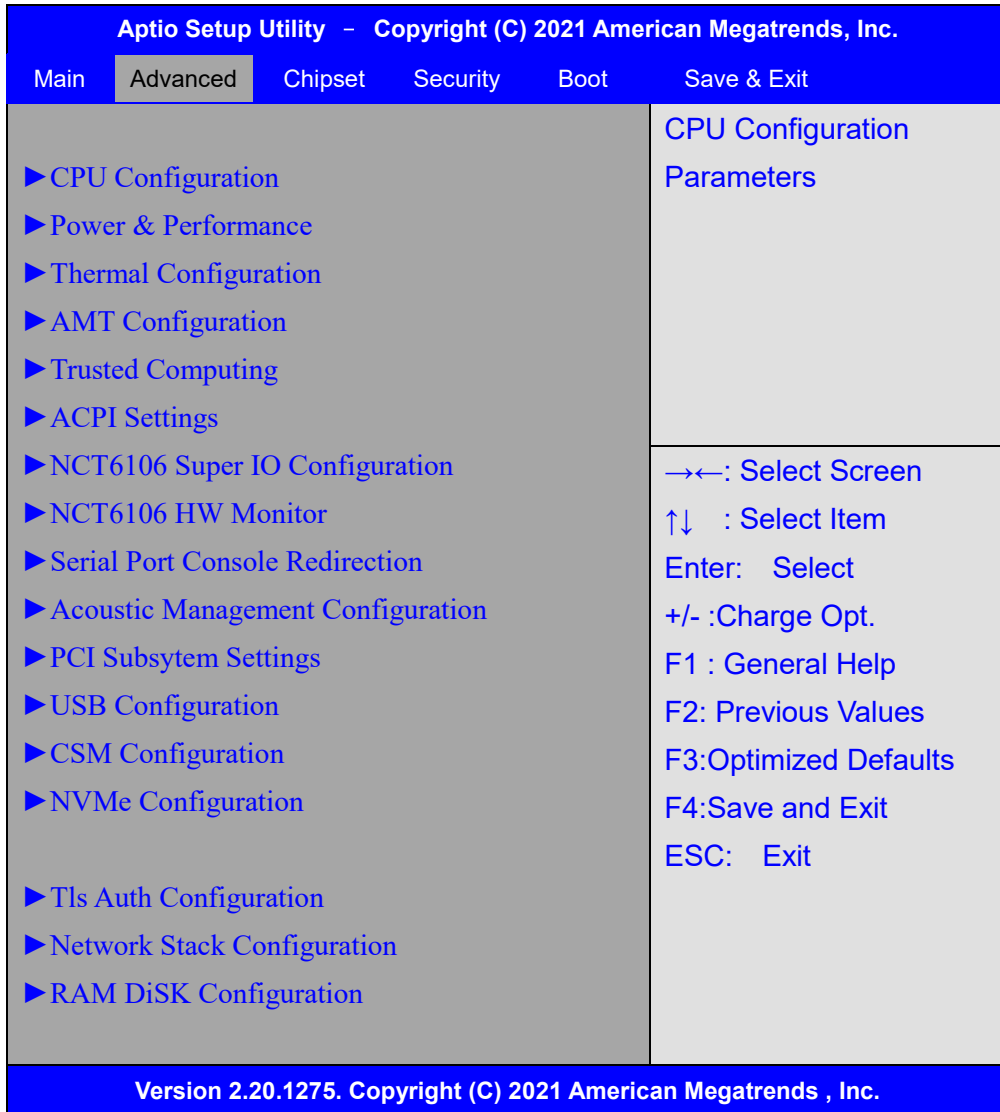

3.4.1 CPU Configuration

Type	Intel (R) Core (TM)
I5-8365UE CPU@ 1.60GHz	
ID	0x806EC
Speed	1800 MHz
L1 Date Cache	32 KB x 4
L1 Instruction Cache	32 KB x 4
L2 Cache	256 KB x 4
L3 Cache	6 MB
L4 Cache	N/A
VMX	Supported
SMX/TXT	Supported
C6DRAM	[Enabled]
SW Guard Extensions(SGX)	[Software Controlled]
Select Owner EPOCH input type	[No Change In Owner EPOCHs]

CPU Flex Ratio Override	[Disabled]
CPU Flex Ratio Settings	18
Hardware Prefetcher	[Enabled]
Adjacent Cache Line Prefetch	[Enabled]
Intel (VMX)Virtualization Technology	[Enabled]
PECI	[Enabled]
Active Processor Cores	[All]
BIST	[Disabled]
AP threads Idle Manner	[MWAIT Loop]
AES	[Enabled]
MachineCheck	[Enabled]
MonitorMWait	[Enabled]
Intel Trusted Execution Technology	[Disabled]
Alias Check Request	[Disabled]
DPR Memory Size (MB)	4
Reset AUX Content	[no]

► **BIOS Guard**

FCLK Frequency for Early Power On	[Auto]
Voltage Optimization	[Auto]

3.4.2 Power & Performance

► **CPU – Power Management Control**

Boot performance mode	[Max Non-Turbo Performance]
Intel(R) Speed Step(tm)	[Enabled]
Race To Halt (RTH)	[Enabled]
Intel(R) Speed Shift Technology	[Enabled]
HDC Control	[Enabled]

***Note:** If the turbo boot is setting, the internal temperature of HMI will raise, it will shorten the CPU, LCD or product life time . Beside, the power consumption of the system will raise at the same time.

► **View/Configure Turbo Options**

► **Config TDP Configurations**

► **CPU VR Settings**

Platform PL1 Enable	[Disabled]
Platform PL2 Enable	[Disabled]
Power Limit 4 Override	[Disabled]
C states	[Disabled]
Thermal Monitor	[Enabled]

Interrupt Redirection Mode Selection	[PAIR with Fixde Priority]
Timed MWAIT	[Disabled]
► Custom P-state Table	
EC Turbo Control Mode	[Disabled]
Energy Performance Gain	[Disabled]
EPG DIMM Idd3N	26
EPG DIMM Idd3P	11
► Power Limit 3 Settings	
Power Limit 3 Override	[Disabled]
► CPU Lock Configuration	
CFG Lock	[Enabled]
Overclocking Lock	[Disabled]
► GT – Power Management Control	
RC6(Render Standby)	[Enabled]
Maximum GT frequency	[Default Max Frequency]
Disabled Turbo GT frequency	[Disabled]

3.4.3 Thermal Configuration

► CPU Thermal Configuration

DTS SMM	[Disabled]
Tcc Activation Offset	0
Tcc offset Time Window	[Disabled]
Tcc offset Clamp Enable	[Disabled]
Tcc offset Lock Enable	[Disabled]
Bi-directional PROCHOT#	[Enabled]
Disable PROCHOT# Output	[Enabled]
Disable VR Thermal Alert# Output	[Disabled]
PROCHOT Response	[Disabled]
PROCHOT Lock	[Disabled]
ACPI T-States	[Disabled]
PECI Reset	[Disabled]
PECI C10 Reset	[Disabled]

► Platform Thermal Configuration

Automatic Thermal Reporting	[Disabled]
Critical Trip Point	[119 C (POR)]
Active Trip Point 0	[71 C]

Active Trip Point 0 Fan Speed	100
Active Trip Point 1	[55 C]
Active Trip Point 1 Fan Speed	75
Passive Trip Point	[95 C]
Passive TC1 Value	1
Passive TC2 Value	5
Passive TSP Value	10
Active Trip Points	[Enabled]
Passive Trip Pointst	[Disabled]
Critical Trip Points	[Enabled]
PCH Temp Read	[Enabled]
CPU Energy Read	[Enabled]
CPU Temp Read	[Enabled]
Alert Enable Lock	[Disabled]
CPU Temp	72
CPU Fan Speed	65
▶ DPTF Configuration	
DPTF	[Disabled]

3.4.4 AMT Configuration

ASF Support	[Disabled]
USB Provisioning of AMT	[Disabled]
▶ CIRA Configuration	
▶ ASF Configuration	
▶ Secure Erase Configuration	
▶ OEM Flags Settings	
▶ MEBX Resolution Settings	

3.4.5 Trusted Computing

TPM20 Device Found	
Firmware Version:	13.11
Vendor:	IFX
Security Device Support	[Enabled]
Active PCR banks	SHA-1 , SHA256
Available PCR banks	SHA-1 , SHA256
SHA-1 PCR Bank	[Enabled]
SHA256 PCR Bank	[Enabled]

Pending operation	[None]
Platform Hierarchy	[Enabled]
Storage Hierarchy	[Enabled]
Endorsement Hierarchy	[Enabled]
TPM2.0 UEFI Spec Version	[TCG_ 2]
Physical Presence Spec a Version	[1.3]
TPM 20 InterfaceType	[TIS]
Device Select	[Auto]

3.4.6 ACPI Settings

Enable ACPI Auto Configuration:	[Disabled] [Enabled]
Enable Hibernation:	[Enabled] [Disabled]
ACPI Sleep State:	[S3 (Suspend to RAM)] [Suspend Disabled]
Lock Legacy Resources:	[Disabled] [Enabled]
S3 Video Repost:	[Disabled] [Enabled]

3.4.7 NCT6106 Super IO Configuration

Super IO Chip	NCT6106D
▶ Serial Port 1 Configuration	
Serial port	[Enabled] [Disabled]
Device Settings	IO=3F8h ; IRQ=4 ;
Change Settings	[Auto]
▶ Serial Port 2 Configuration	
Serial port	[Enabled] [Disabled]
Device Settings	IO=2F8h ; IRQ=3 ;
Change Settings	
COM2 Mode Config	[RS-232 Mode] [RS-485 Mode] [RS-422 Mode]
▶ Serial Port 3 Configuration	

Serial port	[Enabled]
	[Disabled]
Device Settings	IO=3E8h ; IRQ=6 ;
Change Settings	[Auto]
▶ Serial Port 4 Configuration	
Serial port	[Enabled]
	[Disabled]
Device Settings	IO=2E8h ; IRQ=6 ;
Change Settings	[Auto]
▶ Serial Port 5 Configuration	
Serial port	[Enabled]
	[Disabled]
Device Settings	IO=2F0h ; IRQ=6 ;
Change Settings	[Auto]
COM5 Mode Config	[RS-485 Mode]
	[RS-422 Mode]
▶ Serial Port 6 Configuration	
Serial port	[Enabled]
	[Disabled]
Device Settings	IO=2E0h ; IRQ=6 ;
Change Settings	[Auto]
COM6 Mode Config	[RS-485 Mode]
	[RS-422 Mode]
WatchDog Controller Settings	
WatchDog Mode Select	[Disabled]

3.4.8 NC6106D Hardware Monitor

Pc Health Status

SYS temperature	: +39 C
CPU DIE temperature	: +52 C
CPU FAN Speed	: N/A
VORE	: +0.712 V
12V :	: +13.969 V
5V :	: +5.440 V
3.3V :	: +3.456 V

3.4.9 Serial Port Console Redirection

COMO

Console Redirection [Disabled]

► Console Redirection settings

COM1(Pci Bus0,Dev0,Func0) (Disabled)

Console Redirection Port Is Disabled

Legacy Console Redirection

► Legacy Console Redirection Settings

Redirecton COM Port [COMO]
[COM1 (PCI Bus0 , Devo , Func0)(Disabled)]

Resolution [80x24]
[80x25]

Redirect After POST [Always Enable]
[BootLoader]

When Bootloader is selected,then Legacy Console Redirection is disabled before booting to legacy OS.When Always Enable is selected,then Legacy Console Redirecion is enabled for legacy OS.Default setting for this option is set to Always Enable.

Serial Port for Out-of-Band Management/
Windows Emergeny Management Services (EMS)

Console Redirection [Disabled]

► Console Redirection settings

3.4.10 Acoustic Management Configuration

3.4.11 PCI Subsystem Settings

AMI PCI Driver Version : A5.01.17

PCI Settings Common for all Devices :

BME DMA Mitigation [Disabled]

Change Settings of the Following PCI Devices :

WARNING: Changing PCI Device(S) Settings may have unwanted side effects ! System may HANG!
PROCEED WITH CAUTION.

3.4.12 USB Configuration

USB Module Version 23

USB Controllers:

1XHCI

USB Devices:

1 Keyboard,1 Mouse

Legacy USB Support [Enabled]

XHCI Hand-off [Enabled]

USB Mass Storage Driver Support [Enabled]

USB Hardware delays and time-outs:

USB transfer time-out [20 sec]

Device reset time-out [20 sec]

Device power-up delay [Auto]

3.4.13 CSM Configuration

Compatibility Support Module Configuration

CSM Support [Enabled]

CSM16 Module Version 07.82

GateA20 Active [Upon Request]

Option ROM Messages [Force BIOS]

INT19 Trap Response [Immediate]

HDD Connection Order [Adjust]

Boot option filter [UEFI and Legacy]

[Legacy only]

[UEFI only]

Option ROM execution

Network [Do not launch]

[UEFI]

[Legacy]

Storage [UEFI]

Video [Legacy]

Other PCI devices [UEFI]

3.4.14 NVMe Configuration

3.4.15 Tls Auth Configuration

- ▶ Server CA Configuration
- ▶ Client Cert Configuration

3.4.16 Network Stack Configuration

Network Stack [Disabled]
[Enabled]

3.4.17 RAM DiSK Configuration

Disk Memory Type: [Boot Service Data]
[Reserved]

▶ Create raw

Size (Hex) :

[1]

The valid RAM Disk size should be multiples of the RAM disk block size.

Create & Exit

Discard & Exit

▶ Create from file

Created RAM disk list :

RAM Disk 0 : [0X86BBFF18,0X86BBFF18] [Disabled]
[Enabled]

RAM Disk 1 : [0X86C32018, 0X86C32018] [Disabled]
[Enabled]

RAM Disk 2 : [0X86C41218, 0X86C41218] [Disabled]
[Enabled]

Remove selected RAM disk(s).

3.5 Chipset Settings

Aptio Setup Utility – Copyright (C) 2021 American Megatrends, Inc.

Main	Advanced	Chipset	Security	Boot	Save & Exit
Firmware Configuration [Test] Type C Support [Platform-POR] ▶ System Agent (SA) Configuration ▶ PCH-IO Configuration			Firmware Configuration optios. NOTE:Ignore Policy Update(STR_FW_CONFIG_DEFA ULT_VA LUE) is to skip policy update and will ONLY WORK ON A PLATFORM.		
			→←: Select Screen ↑↓ : Select Item Enter: Select +/- : Charge Opt. F1 : General Help F2: Previous Values F3:Optimized Defaults F4:Save and Exit ESC Exit		
Version 2.20.1275. Copyright (C) 2021 American Megatrends , Inc.					

Firmware Configuration
Type C Support

[Test]
[Platform-FOR]

3.5.1 System Agent (SA) Configuration

SA PCIe Code Version 7.0.108.64
VT-d Supported

▶ Memory Configuration

- ▶ Memory Thermal Configuration
- ▶ Memory Thermal Algorithms

Memory RC Version 0.7.1.111
Memory Frequency 2133 MHz
Memory Timings (Tcl-Trcd-TRP-TRAS) 15-15-15-36

Channel 0 Slot 0 Populated/&Enabled
Size 4096 MB (DDR4)
Number of Ranks 2

Manufacturer	Unknown
Channel 0 Slot 1	Not Populated / Disabled
Channel 1 Slot 0	Not Populated / Disabled
Channel 1 Slot 1	Not Present / Disabled
Memory ratio/reference clock	
Options moved to	
Overclock->Memory->Custom Profile	
menu	
MRC ULT Safe Conifg	[Disabled]
LPDDR Dqds Re-Training	[Enabled]
Safe Mode Support	[Disabled]
Memory Test on Warm Boot	[Enabled]
Maximum Memory Frequency	[Auto]
HOB Buffer Size	[Auto]
Max TOLUD	[Dynamic]
SA GV	[Enabled]
SA GV Low Freq	[MRC default]
Retrain on Fast fail	[Enabled]
BER Support	[Enabled]
Enable RH Prevention	[Enabled]
Row Hammer Solution	[Hardware RHP]
RH Activation Probability	[1/2^11]
Exit On Failure (MRC)	[Enabled]
Probeless Trace	[Disabled]
Enable/Disable IED(Intel Enhanced Debug)	[Disabled]
Ch Hash Support	[Enabled]
Ch Hash Mask	0
Ch Hash Interleaved Bit	[BIT8]
VC1 Read Metering	[Enabled]
Strong Weak Leaker	7
Memory Scrambler	[Enabled]
Force ColdReset	[Disabled]
Channel A DIMM Control	[Enable both DIMMS]
Channel B DIMM Control	[Enable both DIMMS]
Force Single Rank	[Disabled]
Memory Remap	[Enabled]
Time Measure	[Disabled]
DLL Weak Lock Support	[Enabled]
Pwr Down Idle Timer	0

Fast Boot	[Enabled]
Train On Warm boot	[Disabled]
Rank Margin Tool Per Task	[Disabled]
Training Tracing	[Disabled]
Lpddr Mem WL Set	[Set B]
BDAT ACPI Table Support	[Disabled]
BDAT Memory Test Type	[Rank Margin Tool Rank]
Rank Margin Tool Loop Count	0
Lpddr Dram Odt	[Auto]
DDR4 Skip Refresh Enable	[Enabled]
Late Command Training Relaxed	[Disabled]
Reset	

► **Graphics Configuration**

Graphics Turbo IMON Current	31
Skip Scanning of External Gfx Card	[Disabled]

Primary Display	[Auto]
Select PCIE Card	[Auto]

► **External Gfx Primary Display Configuration**

Internal Graphics	[Auto]
GTT Size	[8MB]
Aperture Size	[256MB]
PSMI SUPPORT	[Disabled]
DVMT Pre-Allocated	[32M]
DVMT Total Gfx Mem	[256M]
Intel Graphics Pei Display Peim VDD Enable	[Disabled]
VDD Enable	[Enabled]
PM Support	[Enabled]
PAVP Enable	[Enabled]
Cdynmax Clamping Enable	[Enabled]

Cd Clock Frequency	[675Mhz]
Skip CD Clock Init in S3 Resume	[Disabled]
IUER Button Enable	[Disabled]

► **LCD Control**

Primary IGFX Boot Display	[VBIOS Default] [DP] [LVDS]
LCD Panel Type	[VBIOS Default]

	[640x480 LVDS]
	[800x600 LVDS]
	[1024x768 LVDS]
	[1280x1024 LVDS]
	[1400x1050 LVDS1]
	[1400x1050 LVDS2]
	[1600x1200 LVDS]
	[1280x768 LVDS]
	[1680x1050 LVDS]
	[1920x1200 LVDS]
	[1600x900 LVDS]
	[1280x800 LVDS]
	[1280x600 LVDS]
	[2048x1536 LVDS]
	[1366x768 LVDS]
Panel Scaling	[Auto]
Backlight Control	[PWM Normal]
	[PWM Inverted]
Active LFP	[eDP Port-A]
	[No eDP]
Panel Color Depth	[18 Bit]
	[24 Bit]
Backlight Brightness	255
► Intel(R) Ultrabook Event Support	
IUER Slate Enable	[Disabled]
IUER Dock Enable	[Disabled]
► DMI/OPI Configuration	
► Display setup menu	
Stop Grant Configuration	[Auto]
VT-d	[Enabled]
CHAP Device (B0:D7:F0)	[Disabled]
Thermal Device (B0:D4:F0)	[Enabled]
GNA Device (B0:D8:F0)	[Enabled]
CRID Support	[Disabled]
Above 4GB MMIO BIOS assignment	[Disabled]
X2APIC Opt Out	[Disabled]
IPU Device (B0:D5:F0)	[Disabled]

3.5.2 PCH-IO Configuration

► PCI Express Configuration

PCI Express Clock Gating	[Enabled]
DMI Link ASPM Control	[Auto]
PCIE Port assigned to LAN	7
Port8xh Decode	[Disabled]
Peer Memory Write Enable	[Disabled]
Compliance Test Mode	[Disabled]
PCIe-USB Glitch W/A	[Disabled]
PCIe function swap	[Enabled]

► PCI Express Gen3 Eq Lanes

PCIE1 Cm	6
PCIE1 Cp	2
PCIE2 Cm	6
PCIE2 Cp	2
PCIE3 Cm	6
PCIE3 Cp	2
PCIE4 Cm	6
PCIE4 Cp	2
PCIE5 Cm	6
PCIE5 Cp	2
PCIE6 Cm	6
PCIE6 Cp	2
PCIE7 Cm	6
PCIE7 Cp	2
PCIE8 Cm	6
PCIE8 Cp	2
PCIE9 Cm	6
PCIE9 Cp	2
PCIE10 Cm	6
PCIE10 Cp	2
PCIE11 Cm	6
PCIE11 Cp	2
PCIE12 Cm	6
PCIE12 Cp	2
PCIE13 Cm	6
PCIE13 Cp	2
PCIE14 Cm	6
PCIE14 Cp	2
PCIE15 Cm	6
PCIE15 Cp	2

PCIE16 Cm	6
PCIE16 Cp	2
PCIE17 Cm	6
PCIE17 Cp	2
PCIE18 Cm	6
PCIE18 Cp	2
PCIE19 Cm	6
PCIE19 Cp	2
PCIE20 Cm	6
PCIE20 Cp	2
PCIE21 Cm	6
PCIE21 Cp	2
PCIE22 Cm	6
PCIE22 Cp	2
PCIE23 Cm	6
PCIE23 Cp	2
PCIE24 Cm	6
PCIE24 Cp	2

Override SW EQ Settings [Disabled]

► **IMR Configuration**

PCIe IMR [Disabled]

PCI Express Root Port 1	Lane configured as USB/SATA
PCI Express Root Port 2	Lane configured as USB/SATA
PCI Express Root Port 3	Lane configured as USB/SATA
PCI Express Root Port 4	Lane configured as USB/SATA
► PCI Express Root Port 5	
PCI Express Root Port 6	Lane configured as USB/SATA
PCI Express Root Port 7	Reserved for ethernet
► PCI Express Root Port 8	
► PCI Express Root Port 9	
PCI Express Root Port 10	Shadowed by x2/x4 Port
PCI Express Root Port 11	Shadowed by x2/x4 Port
PCI Express Root Port 12	Shadowed by x2/x4 Port
► PCI Express Root Port 13	
► PCI Express Root Port 14	
► PCI Express Root Port 15	
PCI Express Root Port 16	Lane configured as USB/SATA

► PCIE clocks

► **SATA And RST Configuration**

SATA Controller(s)	[Enabled]
SATA Mode Selection	[AHCI]
SATA Test Mode	[Disabled]

► Software Feature Mask Configuration

Aggressive LPM Support	[Enabled]
------------------------	-----------

Serial ATA Port 0	Empty
Software Preserve	Unknown
Port 0	[Enabled]
Hot Plug	[Disabled]
Configured as ESATA	Hot Plug supported
External	[Disabled]
Spin Up Device	[Disabled]
SATA Device Type	[Hard Disk Drive]
SATA Port 0 DevSlp	[Disabled]
DIT0 Configuration	[Disabled]
DIT0 Value	625
DM Value	15
Serial ATA Port 1	Empty
Software Preserve	Unknown
Port 1	[Enabled]
Hot Plug	[Disabled]
Configured as ESATA	Hot Plug supported
Spin Up Device	[Disabled]
SATA Device Type	[Hard Disk Drive]
SATA Port 1 DevSlp	[Disabled]
DIT0 Configuration	[Disabled]
DIT0 Value	625
DM Value	15
Serial ATA Port 2	Empty
Software Preserve	Unknown
Port 2	[Enabled]
Hot Plug	[Disabled]
Configured as ESATA	Hot Plug supported
Spin Up Device	[Disabled]
SATA Device Type	[Hard Disk Drive]
SATA Port 2 DevSlp	[Disabled]
DIT0 Configuration	[Disabled]
DIT0 Value	625

DM Value 15

► **USB Configuration**

XHCI Compliance Mode	[Disabled]
XDCI Support	[Disabled]
USB2 PHY Sus Well Power Gating	[Enabled]
USB Overcurrent	[Enabled]
USB Overcurrent Lock	[Enabled]
USB Port Disable Override	[Disabled]

► **Security Configuration**

► **SCS Configuration**

► **ISH Configuration**

► **Pch Thermal Throttling Control**

PCH LAN Control	[Enabled]
LAN Wake From DeepSx	[Enabled]
Wake on LAN Enable	[Enabled]
SLP_LAN# Low on DC Power	[Enabled]
Disqualify GBE Disconnect And ModPhy PG	[Disabled]
Sensor Hub Type [None]	
DeepSx Power Policies	[Disabled]
Wake on WLAN and BT Enable	[Disabled]
Disable DSX ACPRESENT Pulldown	[Disabled]
CLKRUN# logic [Enabled]	
Serial IRQ Mode	[Continuous]
State After G3	[S0 State] [S5 State]

3.6 Security Settings

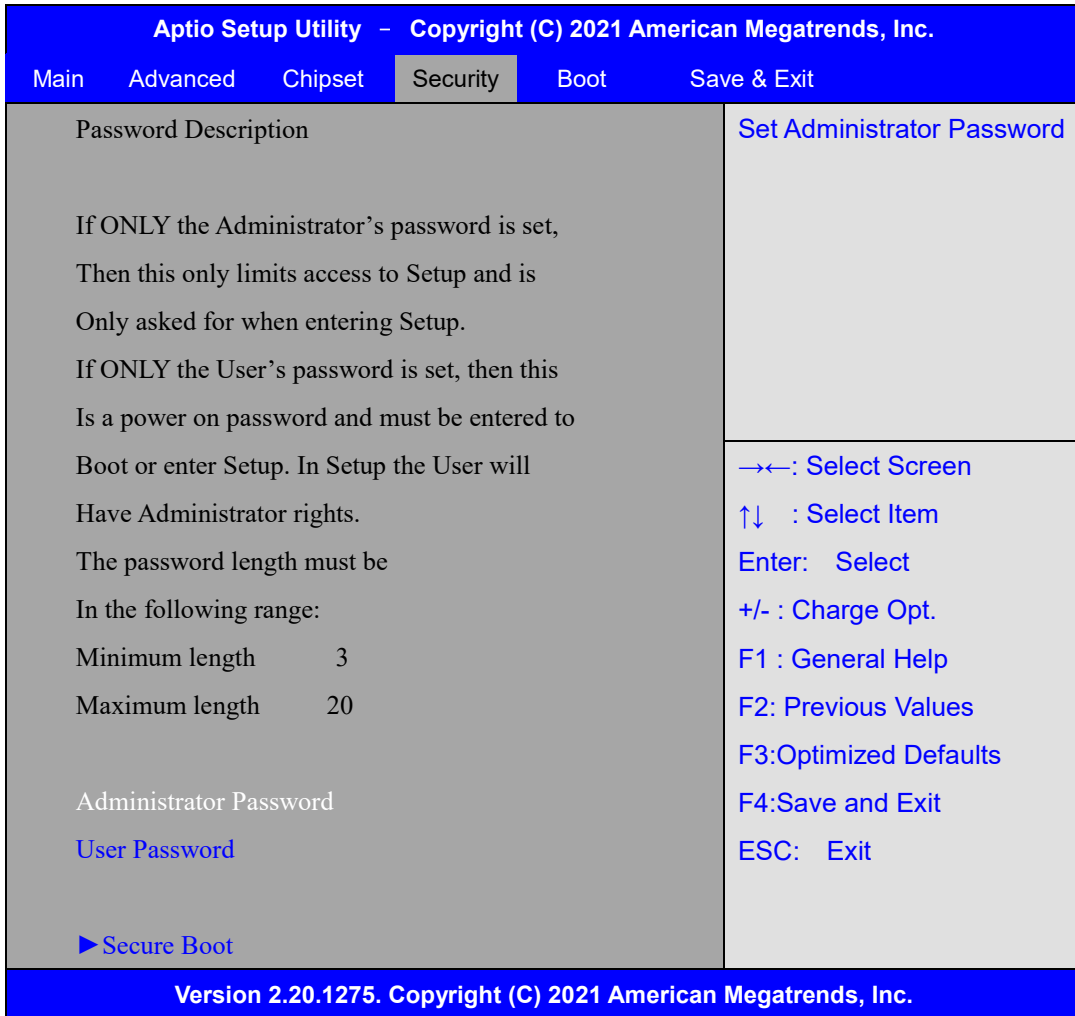

3.6.1 Administrator Password



3.6.2 User Password



Type the password with up to 20 characters and then press **<Enter>** key. This will clear all previously typed CMOS passwords. You will be requested to confirm the password. Type the password again and press **<Enter>** key. You may press **<Esc>** key to abandon password entry operation.

To clear the password, just press **<Enter>** key when password input window pops up. A confirmation message will be shown on the screen as to whether the

password will be disabled. You will have direct access to BIOS setup without typing any password after system reboot once the password is disabled.

Once the password feature is used, you will be requested to type the password each time you enter BIOS setup. This will prevent unauthorized persons from changing your system configurations.

Also, the feature is capable of requesting users to enter the password prior to system boot to control unauthorized access to your computer. Users may enable the feature in Security Option of Advanced BIOS Features. If Security Option is set to System, you will be requested to enter the password before system boot and when entering BIOS setup; if Security Option is set to Setup, you will be requested for password for entering BIOS setup.

3.6.3 Secure Boot

System Mode	Setup
Secure Boot	[Disabled] Not Active

Secure Boot Mode	[Custom]
▶ Restore Factory Keys	
▶ Restore To Setup Mode	

▶ Key Management	
Vendor Keys	Valid
Factory Key Provision	[Disabled]

- ▶ Restore Factory Keys
- ▶ Restore To Setup Mode
- ▶ Export Secure Boot variables
- ▶ Enroll Efi Image

Device Guard Ready
▶ Remove 'UEFI CA' from DB
▶ Restore DB defaults

Secure Boot variables		Size		Keys		Key Source
▶ Platform Key(PK)		0		0		No Keys
▶ Key Exchange Keys		0		0		No Keys
▶ Authorized Signatures		0		0		No Keys
▶ Forbidden Signatures		0		0		No Keys
▶ Authorized TimeStamps		0		0		No Keys
▶ OsRecovery Signatures		0		0		No Keys

3.7 Boot Settings

Aptio Setup Utility – Copyright (C) 2021 American Megatrends, Inc.					
Main	Advanced	Chipset	Security	Boot	Save & Exit
Boot Configuration					Number of seconds toWait
Setup Prompt Timeout			1		for
Bootup Numlock State			[Off]		Setup Activation key.
Quiet Boot			[Disabled]		65535(0xFFFF)means
Boot Option Priorities					Indef
Fast Boot			[Disabled]		inite waiting.
					→←: Select Screen
					↑↓ : Select Item
					Enter: Select
					+/- : Change Opt.
					F1 : General Help
					F2: Previous Values
					F3:Optimized Defaults
					F4:Save and Exit
					ESC: Exit
Version 2.20.1275. Copyright (C) 2021 American Megatrends, Inc.					

Setup Prompt Timeout	1
Bootup Numlock State	[Off]
Quiet Boot	[Disabled]
Boot Option Priorities	
Fast Boot	[Disabled]

3.8 Save & Exit Settings

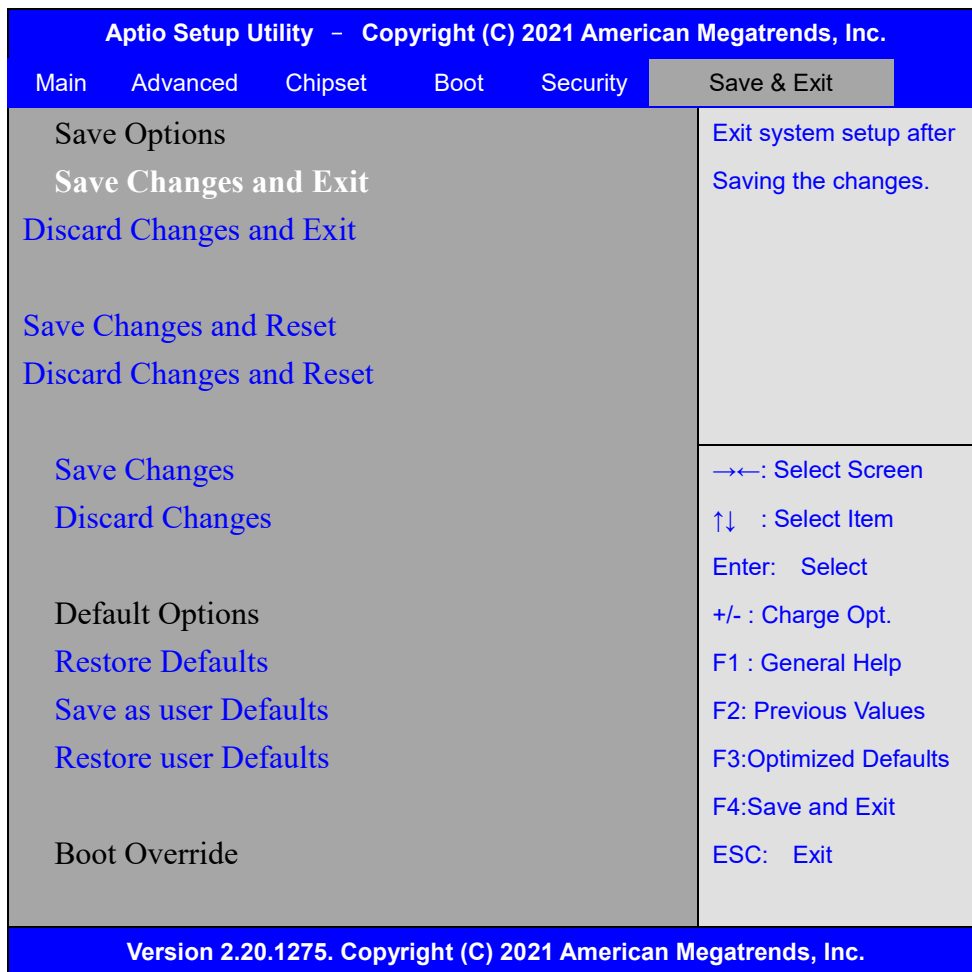

Save Options

Save Changes and Exit

Save & Exit Setup save Configuration and exit ?

[Yes]

[No]

Discard Changes and Ext

Exit Without Saving Quit without saving?

[Yes]

[No]

Save Changes and Reset

Save configuration and Reset

[Yes]

[No]

Discard Changes and Reset

Reset Without saving?

[Yes]

[No]

Save Changes

Save configuration?

[Yes]

[No]

Discard Changes

Load Previous Values?

[Yes]

[No]

Default Options

Restore Default

Load Optimized Defaults?

[Yes]

[No]

Save as User Default

Save configuration?

[Yes]

[No]

Restore User Default

Restore User Defaults?

[Yes]

[No]

Boot Override

Chapter 4

Installation of Drivers

This chapter describes the installation procedures for software and drivers under the windows 10. The software and drivers are included with the motherboard. The contents include **Intel Chipset, Graphics chipset driver, Audio driver, Intel® management engine interface, and LAN driver; the resistive touch driver.** The instructions are as below.

Important Note:

After installing your Windows operating system, you must install first the Intel Chipset Software Installation Utility before proceeding with the installation of drivers.



4.1 Intel Chipset

To install the Intel chipset driver, please follow the steps below.

Step 1. Select **Intel Chipset** from the list

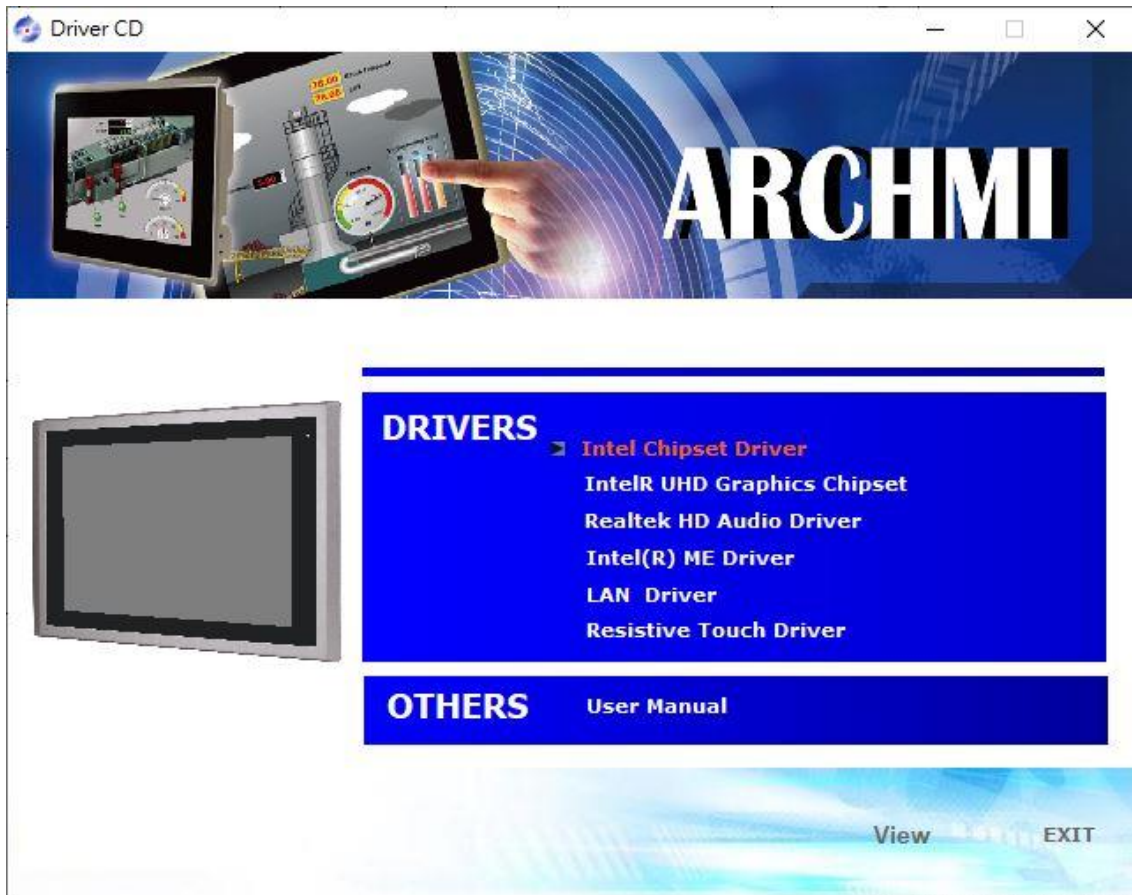

Step 2. Here is welcome page. Please make sure you save and exit all programs before install. Click **Next**.

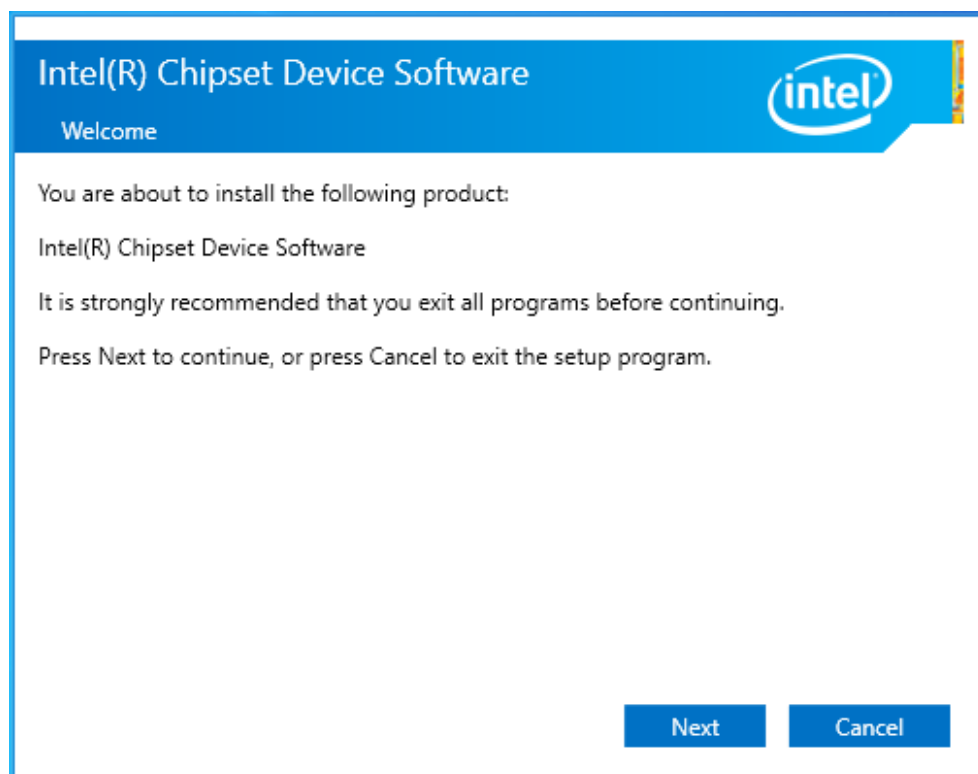

Step 3. Read the license agreement. Click **Accept** to accept all of the terms of the license agreement.

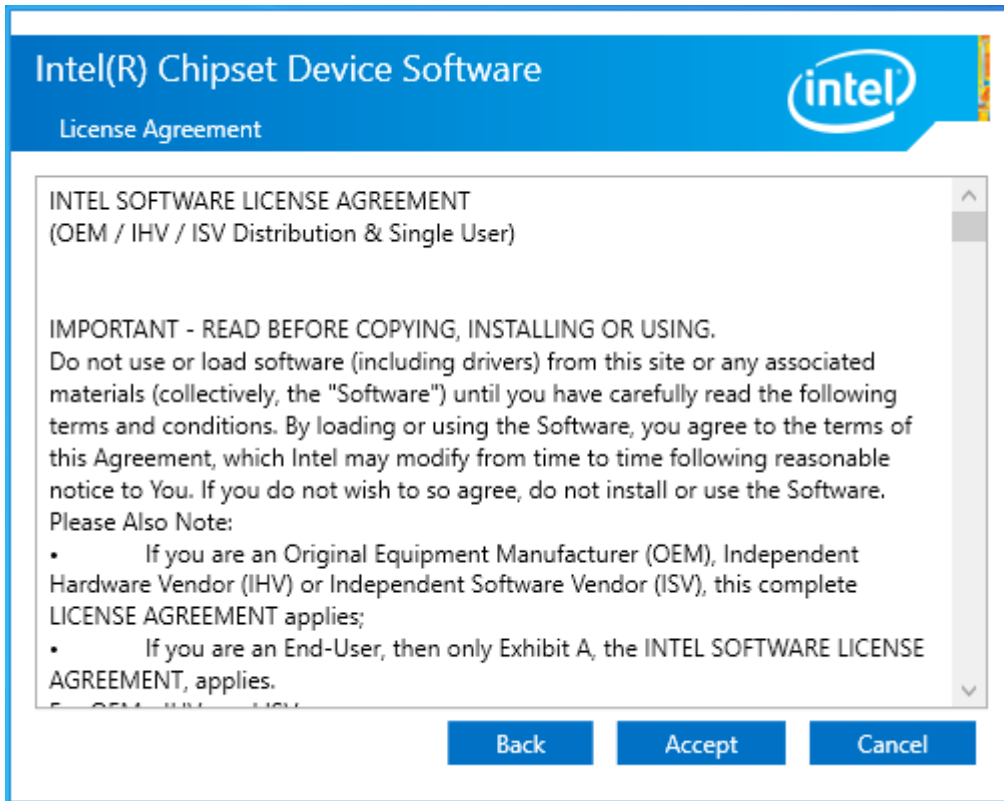

Step 4. Click **Install** to begin the installation.

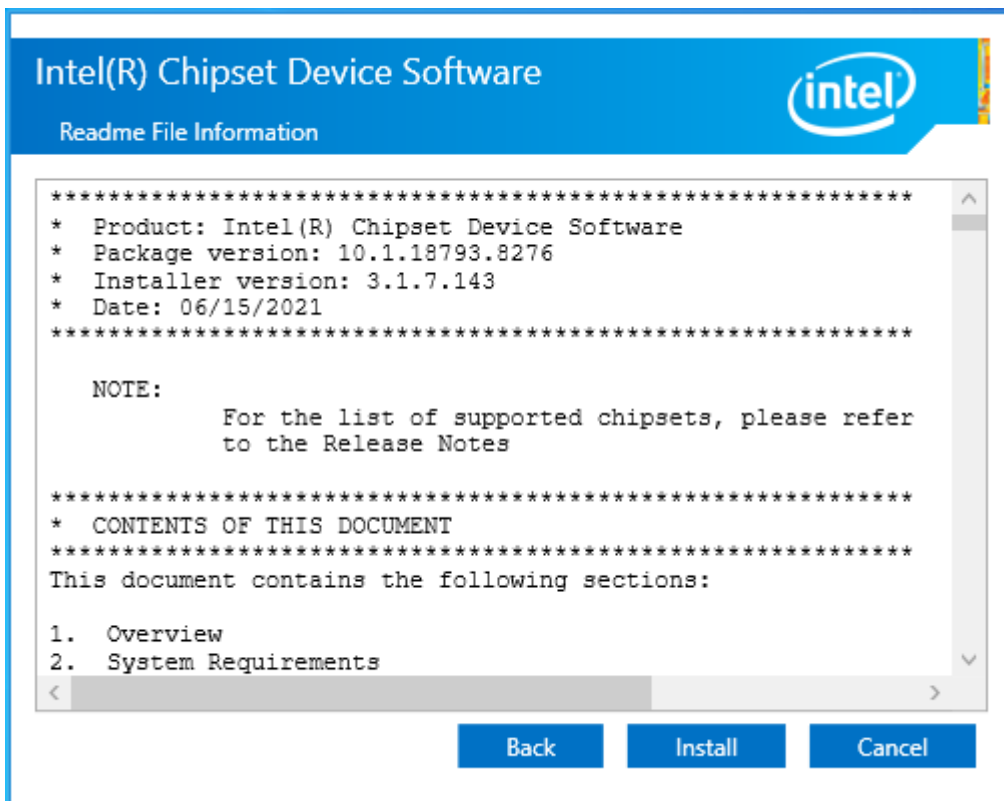

Step 5. Select **Restart Now** to reboot your computer for the changes to take effect.

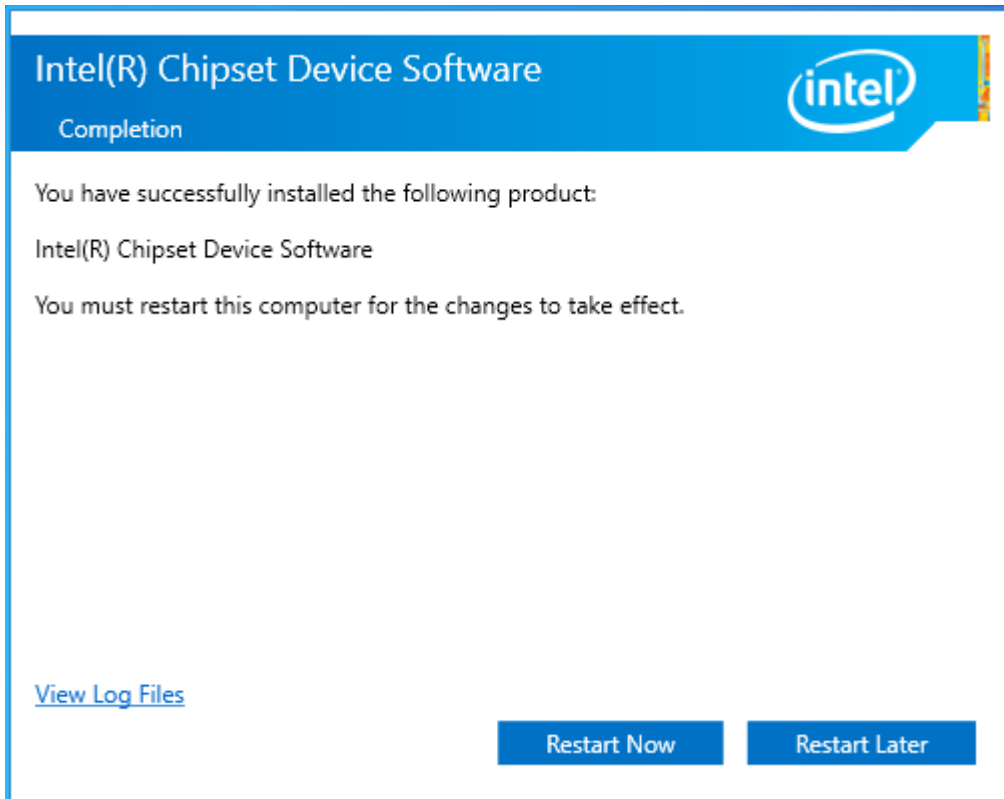

4.2 Intel® HD Graphics Chipset

To install the Intel® HD Graphics Chipset, please follow the steps below.

Step 1. Select Intel® UHD Graphics Chipset from the list.

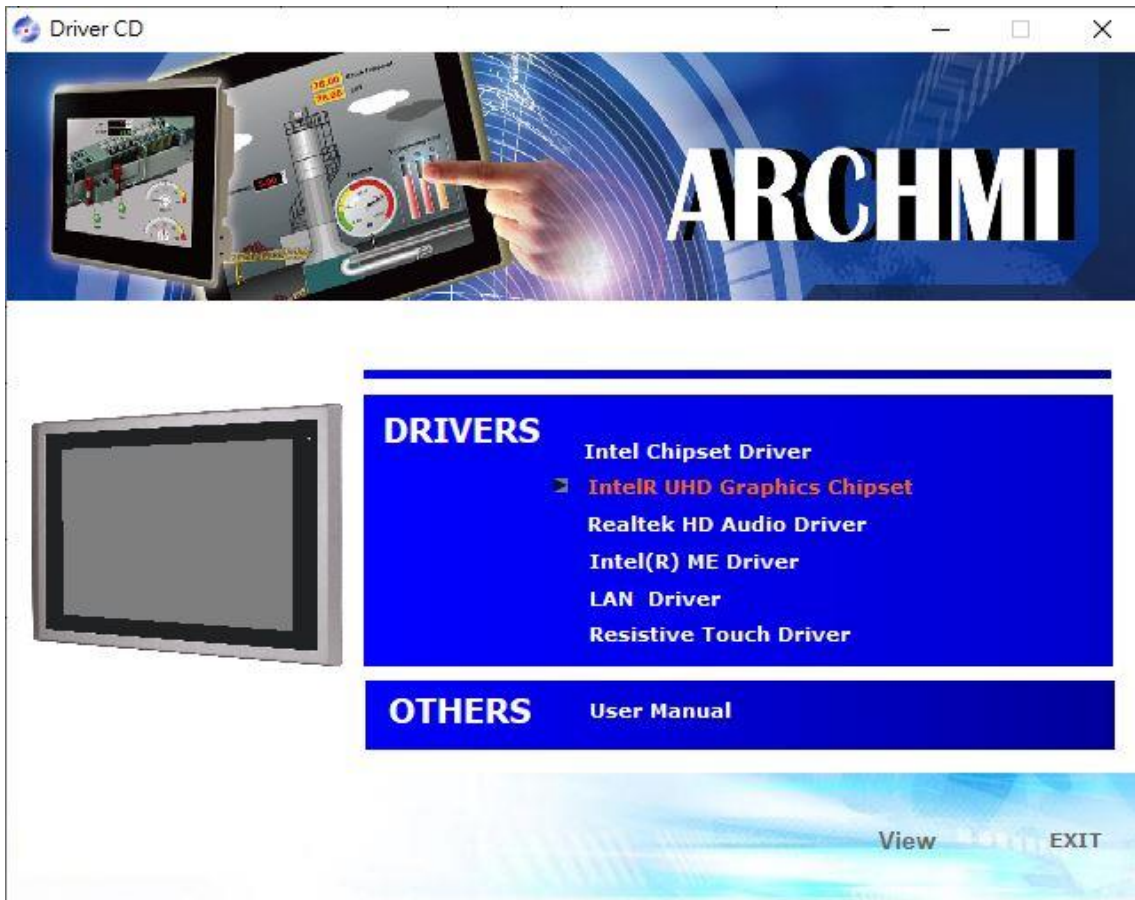

Step 2. . Click Begin installation.



Step 3. Read the license agreement. Click **Yes** to accept all of the terms of the license agreement. And Click **Next** to setup program

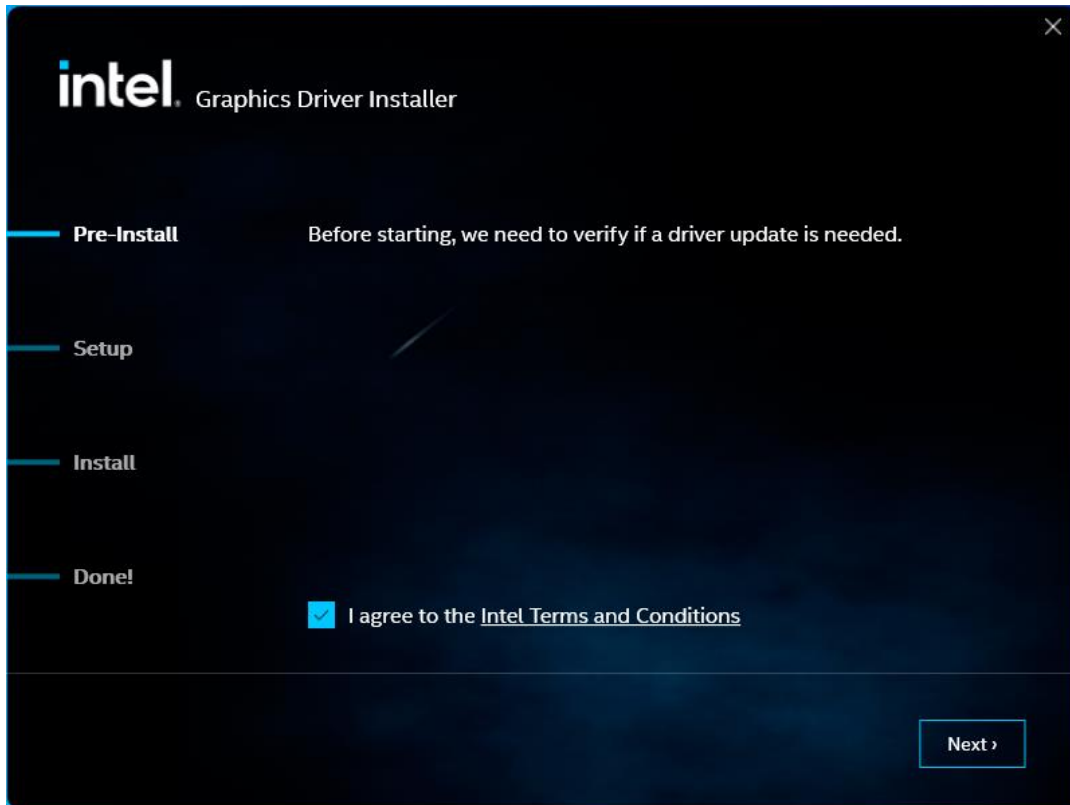

Step 4. Choose **Install** function and Click **Start** to setup program.

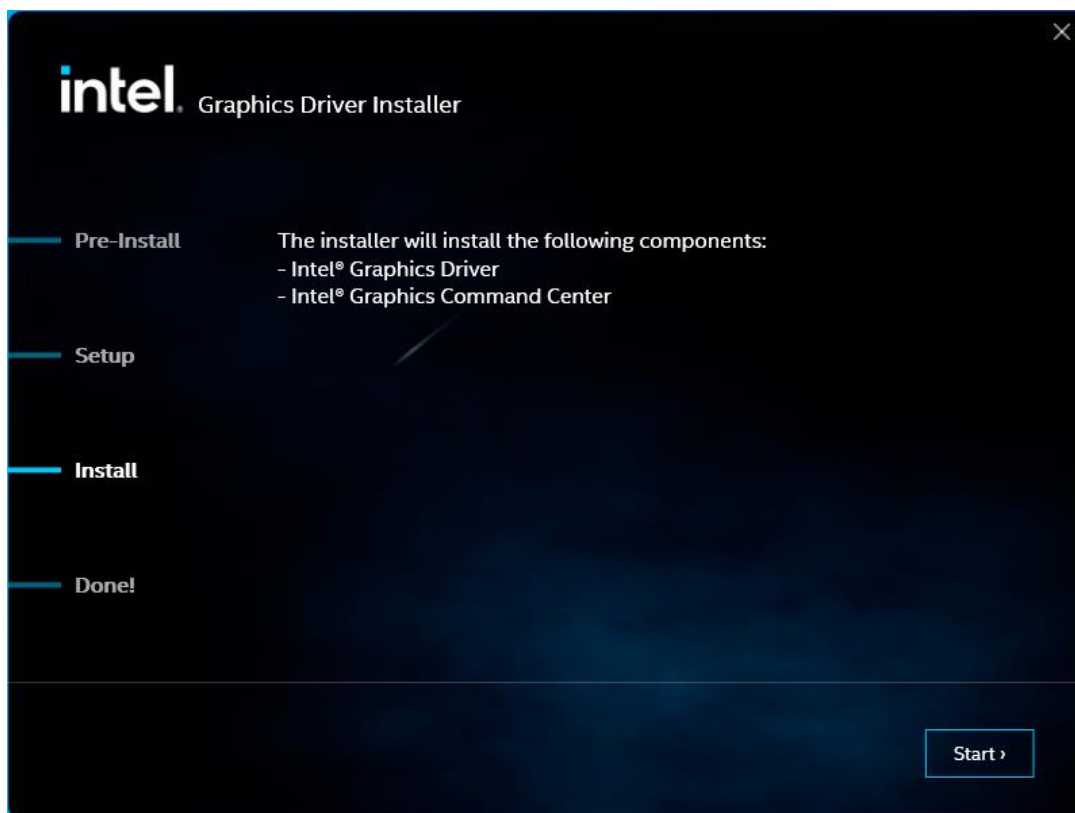

Step 5. Click **Finish** to complete installation.

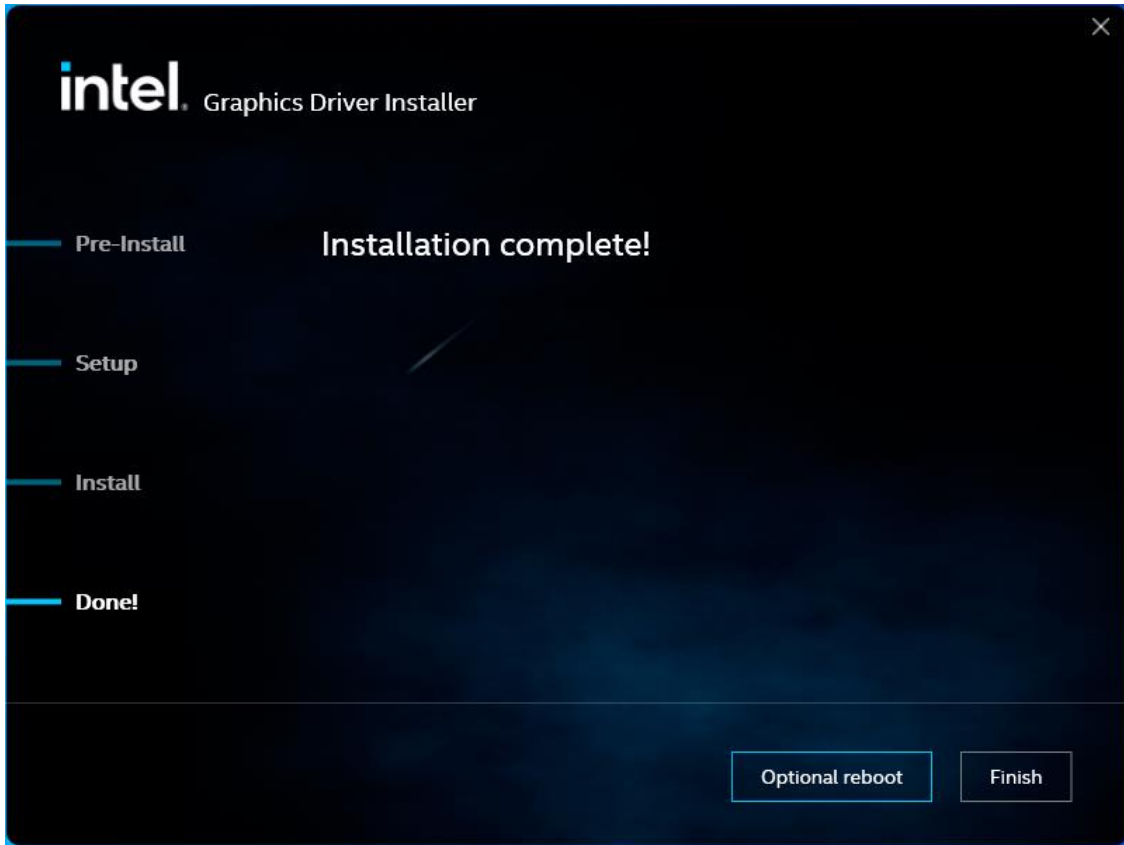

4.3 Realtek HD Audio Driver Installation

To install the Realtek HD Audio Driver, please follow the steps below.

Step 1. Select **Realtek HD Audio Driver** from the list

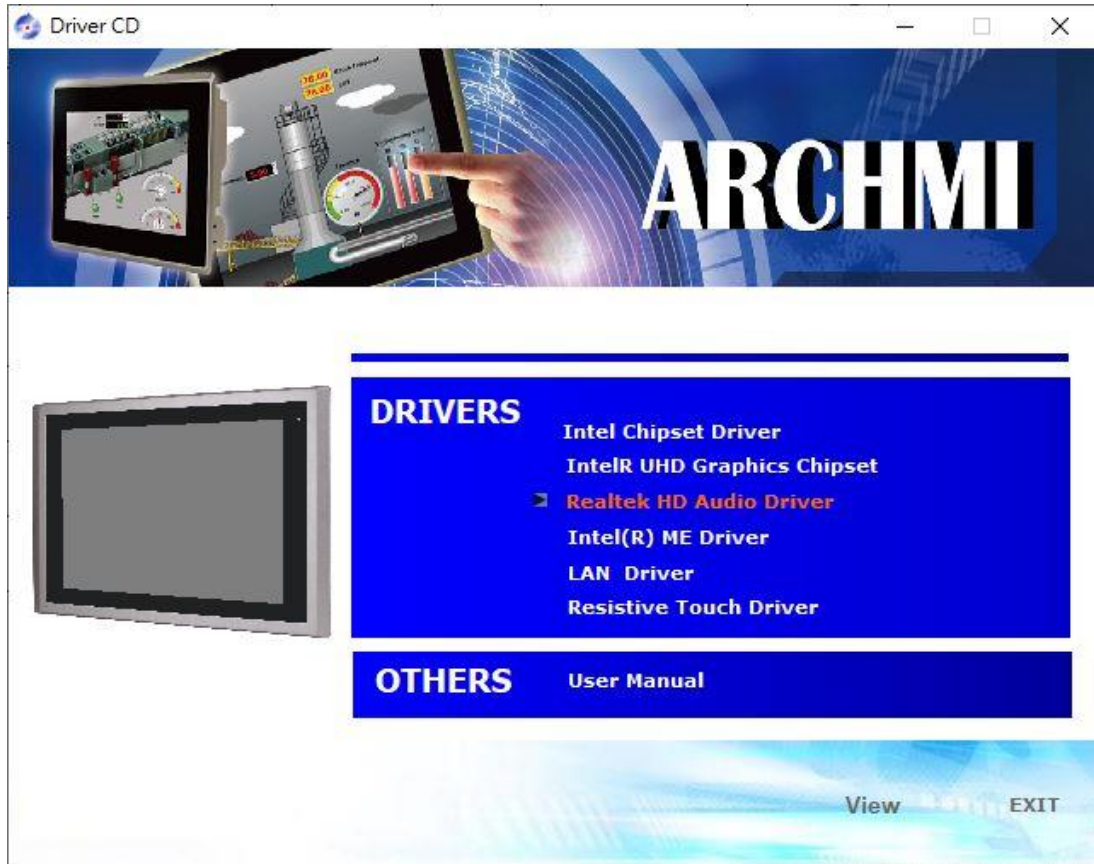

Step 2. Click **Next** to continue.

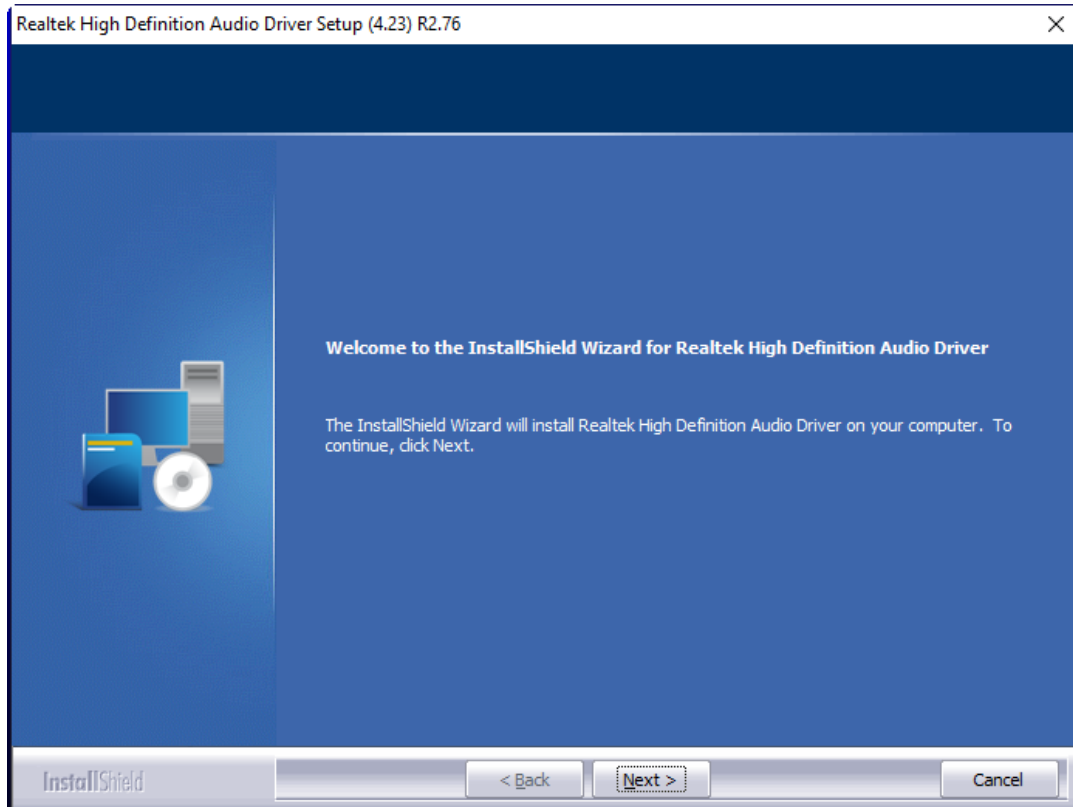

Step 3. Click Yes, I want to restart my computer now. Click **Finish** to complete the installation.

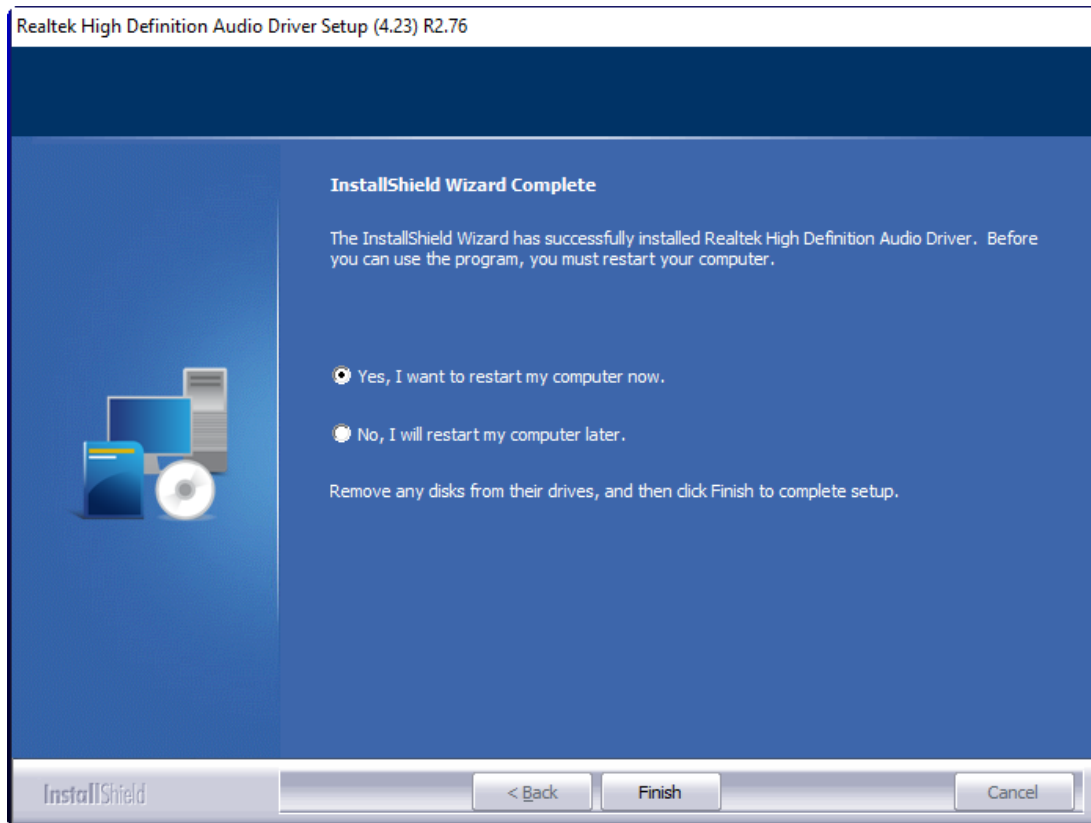

4.4 Intel® Management Engine Interface

To install the Intel® Management Engine Interface, please follow the steps below.

Step 1. Select Intel® Management Engine Interface from the list



Step 2. Select setup language you need. Click **Next** to continue.

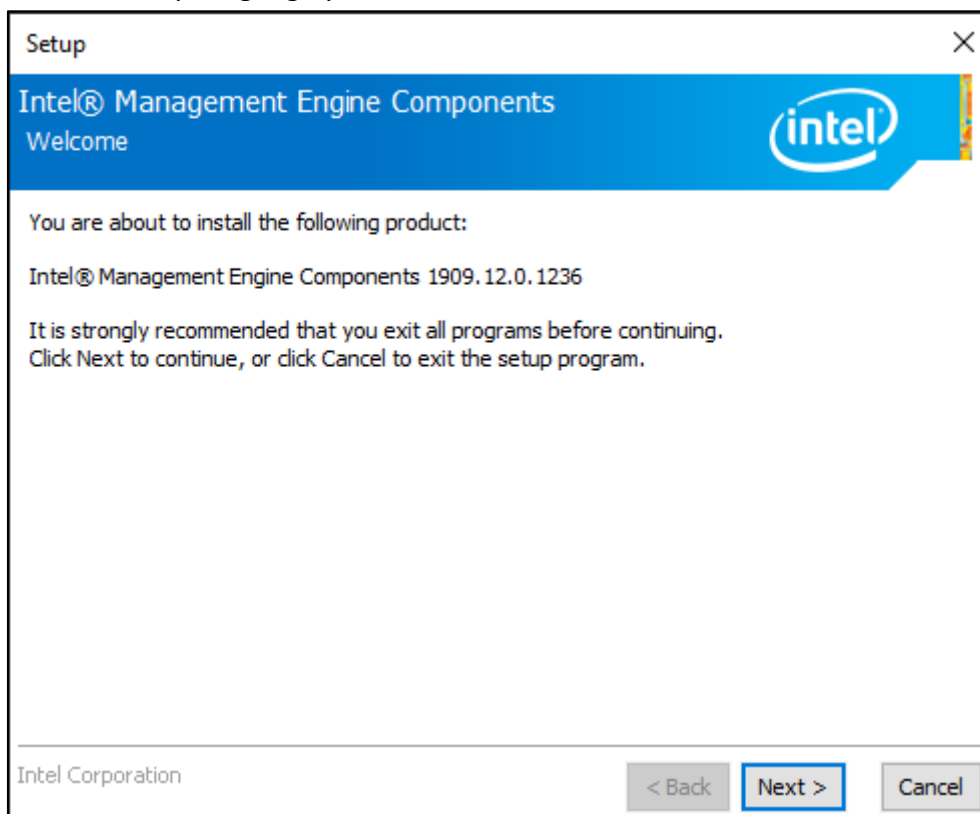

Step 3. Choose **I accept the terms in the License Agreement** and click **Next** to begin the installation.

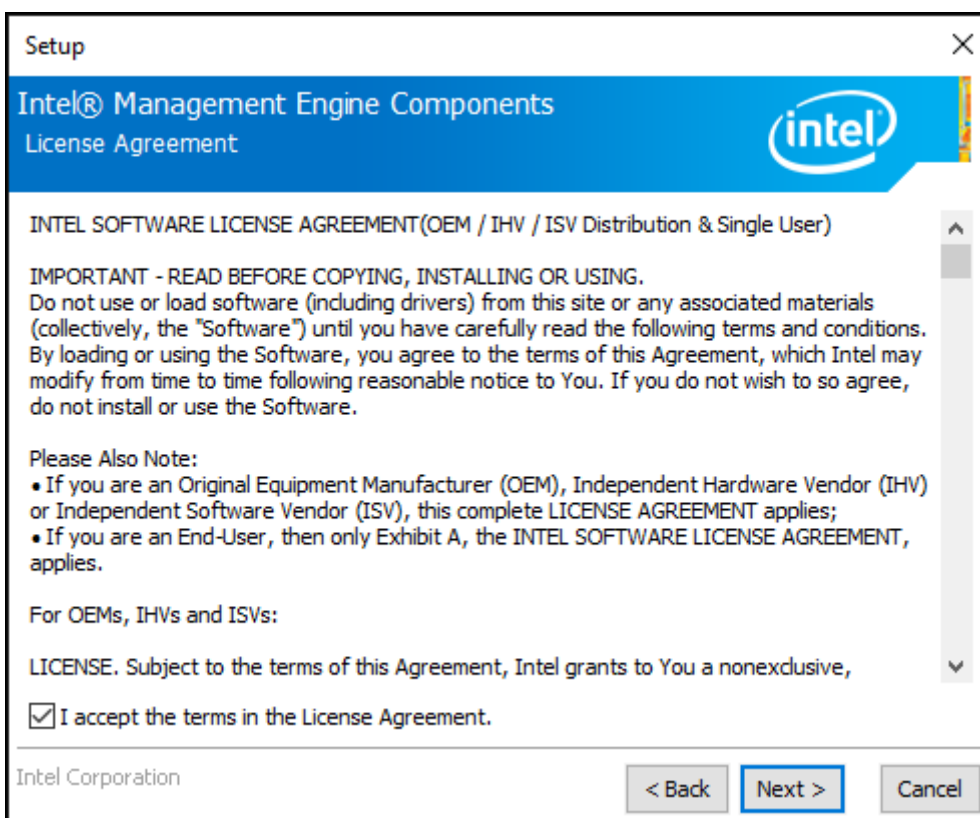

Step 4. Click **Next** to continue.

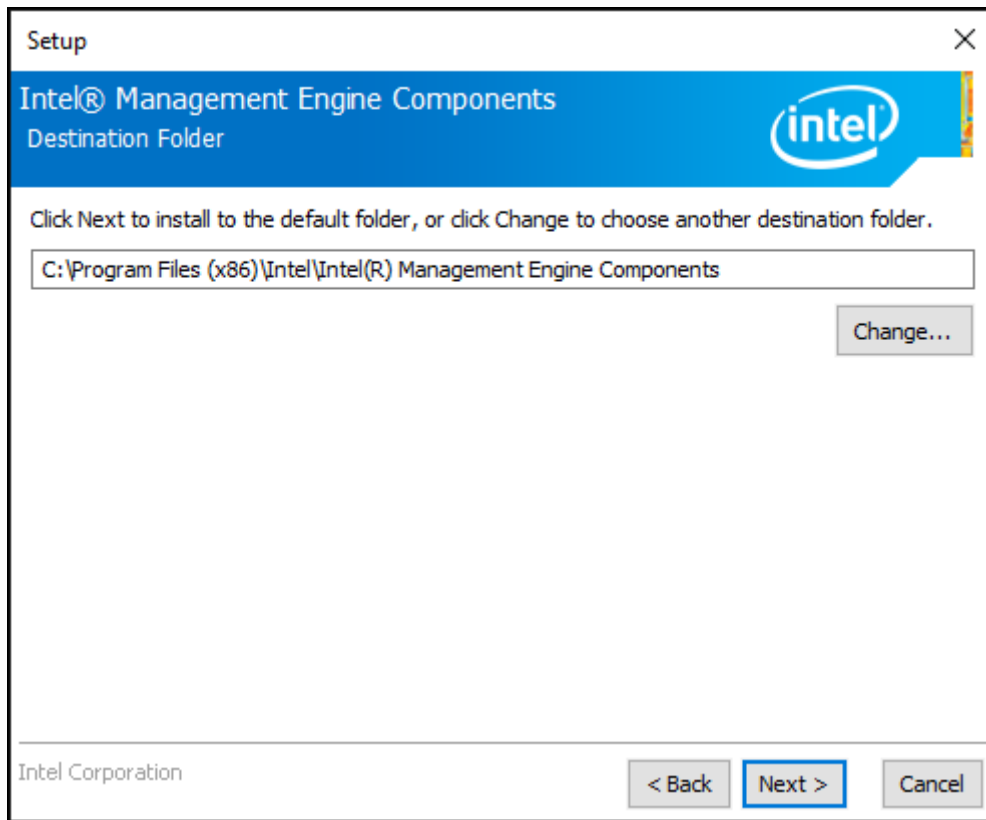

Step 5. Click **Finish** to complete the installation.

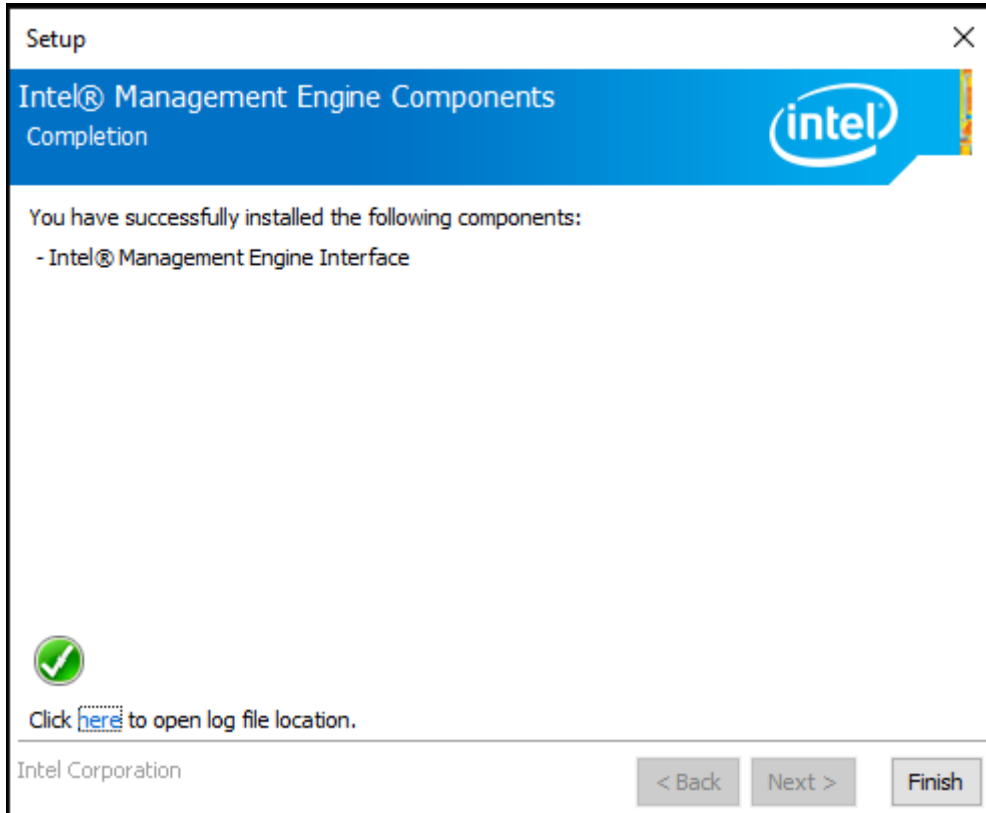

4.5 LAN Driver

To install the LAN driver, please follow the steps below.

Step 1. Select **LAN Driver** from the list



Step 2. Click **Next** to continue.

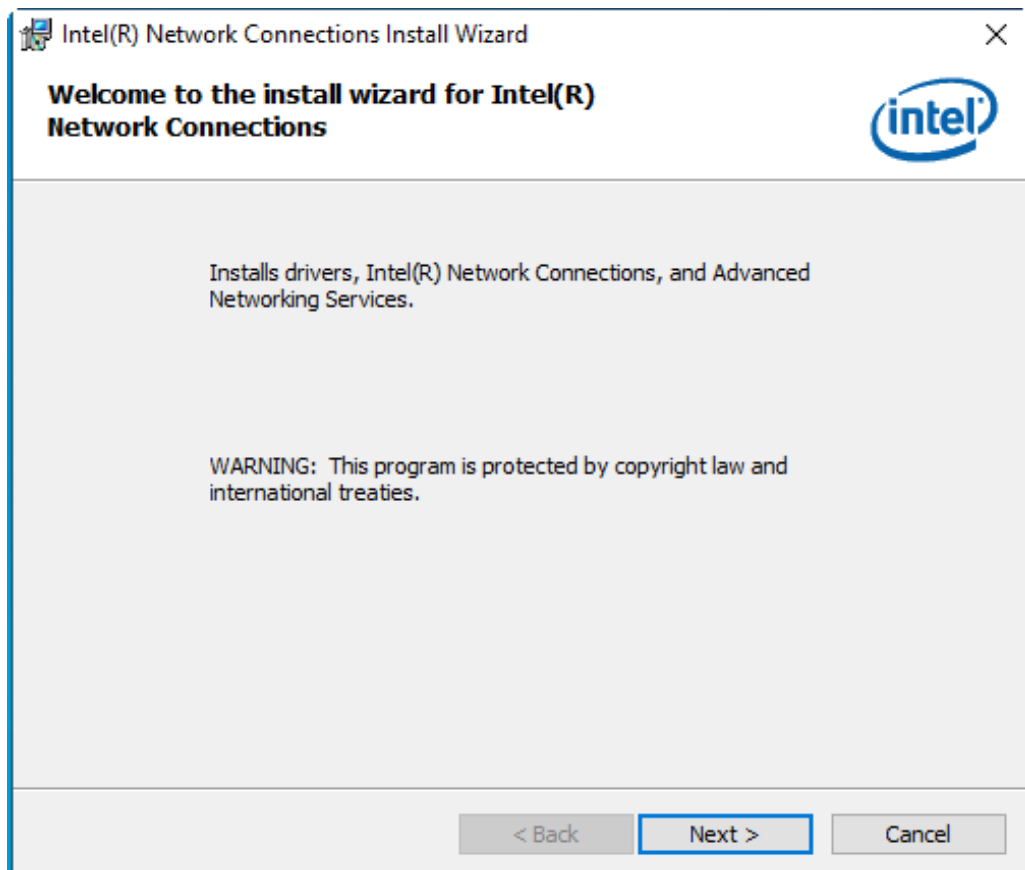

Step 3. Choose **I accept the terms in the License Agreement** and click **Next** to begin the installation.

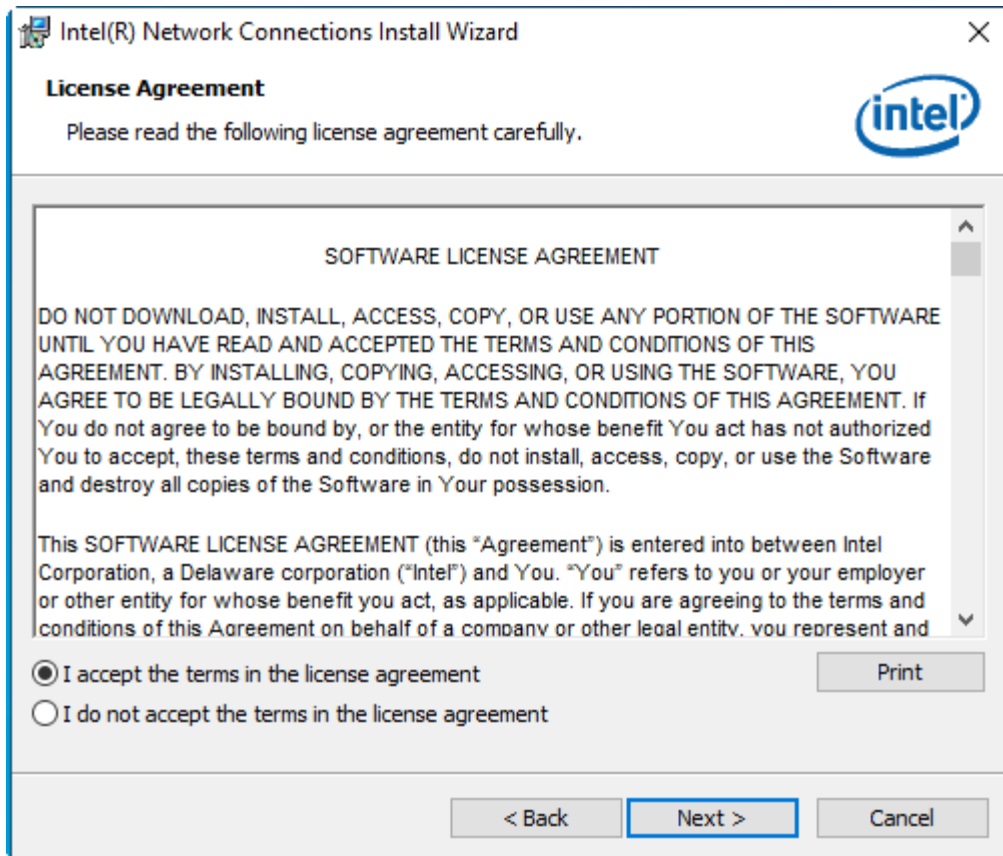

Step 4. Click **Next** to continue.

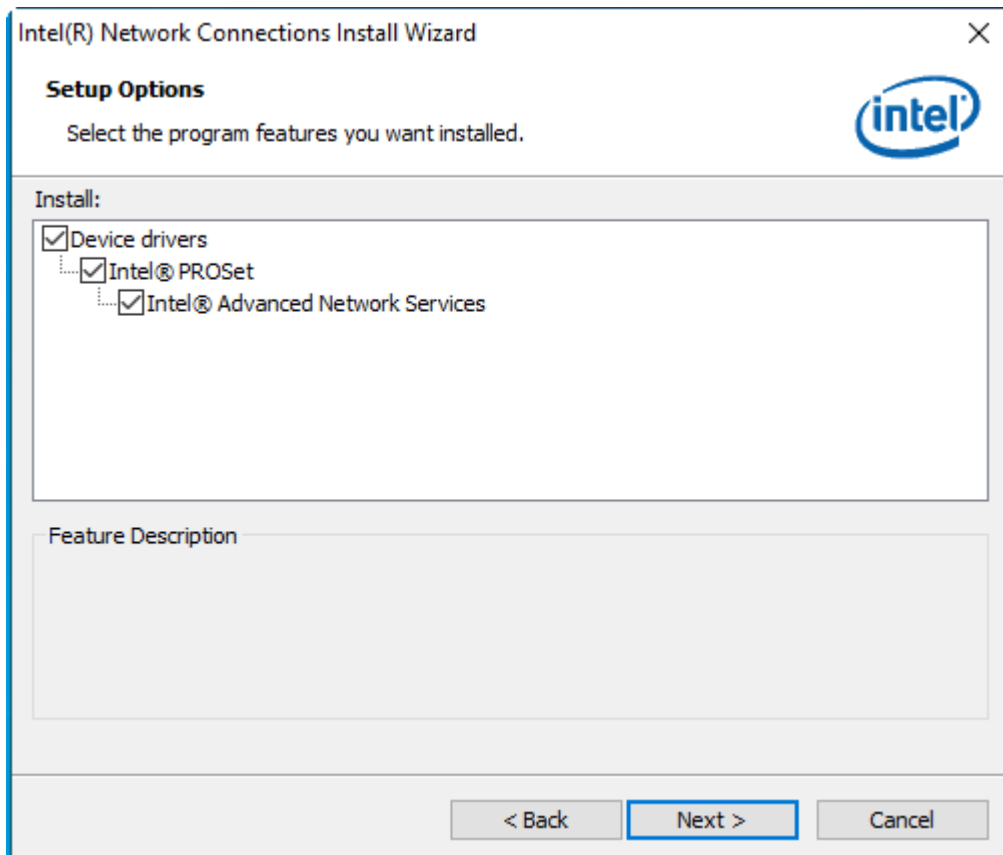

Step 5. Click **Install** to begin the installation.

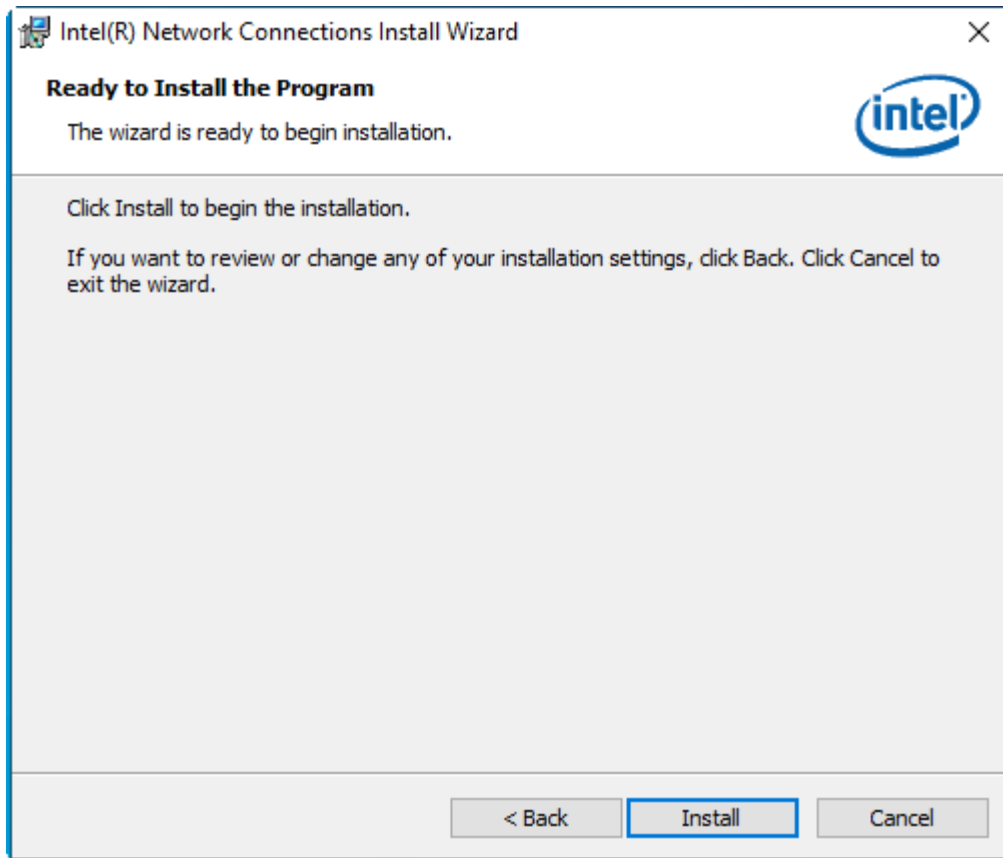

4.6 Touch Screen Installation

This chapter describes how to install drivers and other software that will allow your touch screen work with different operating systems.

4.6.1 Windows 10 Universal Driver Installation for PenMount 6000 Series

Before installing the Windows 10 driver software, you must have the Windows 10 system installed and running on your computer. You must also have one of the following PenMount 6000 series controller or control boards installed: PM6500, PM6300.

Resistive Touch

If you have an older version of the PenMount Windows 7 driver installed in your system, please remove it first. Follow the steps below to install the PenMount DMC6000 driver.

Step 1. Insert the product CD, the screen below would appear. Click **Touch Panel Driver** from the list.



Step 2. Click **Next** to continue.



Step 4. Read the license agreement. Click **I Agree** to agree the license agreement.

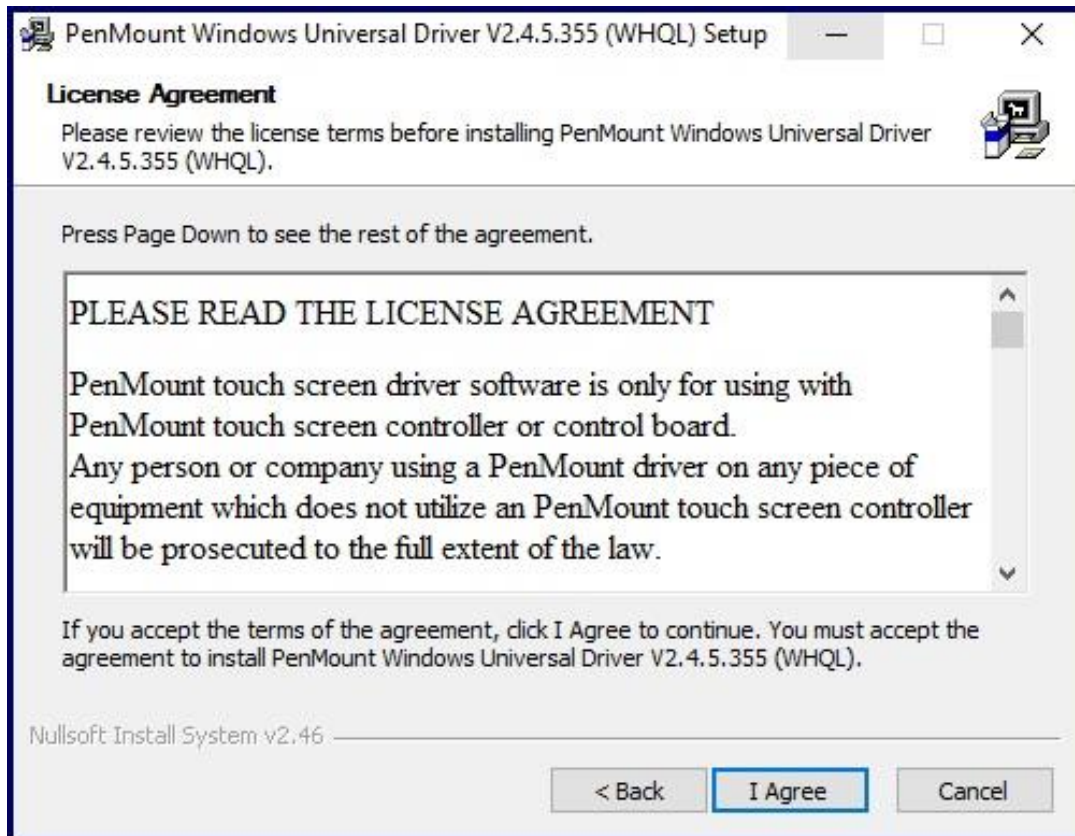

Step 5. Choose the folder in which to install PenMount Windows Universal Driver. Click **Install** to start the installation.

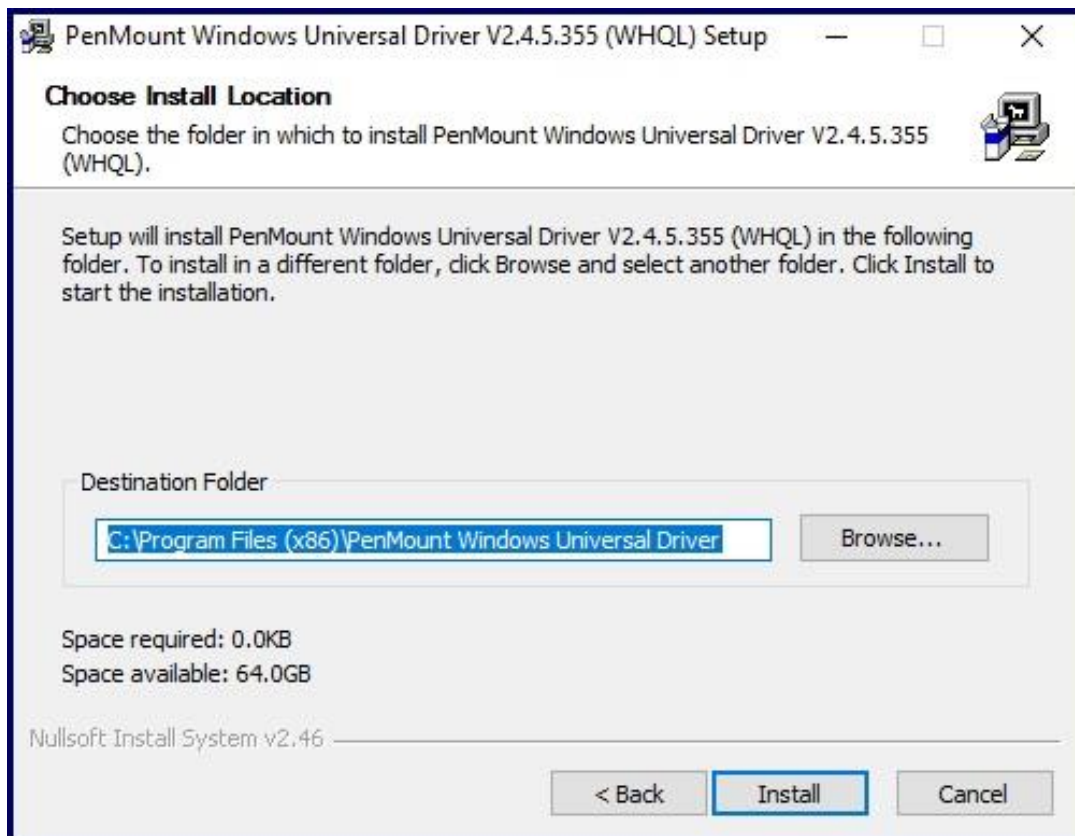

Step 6. Click **Yes** to continue.



Step 7. Click **Finish** to complete installation.

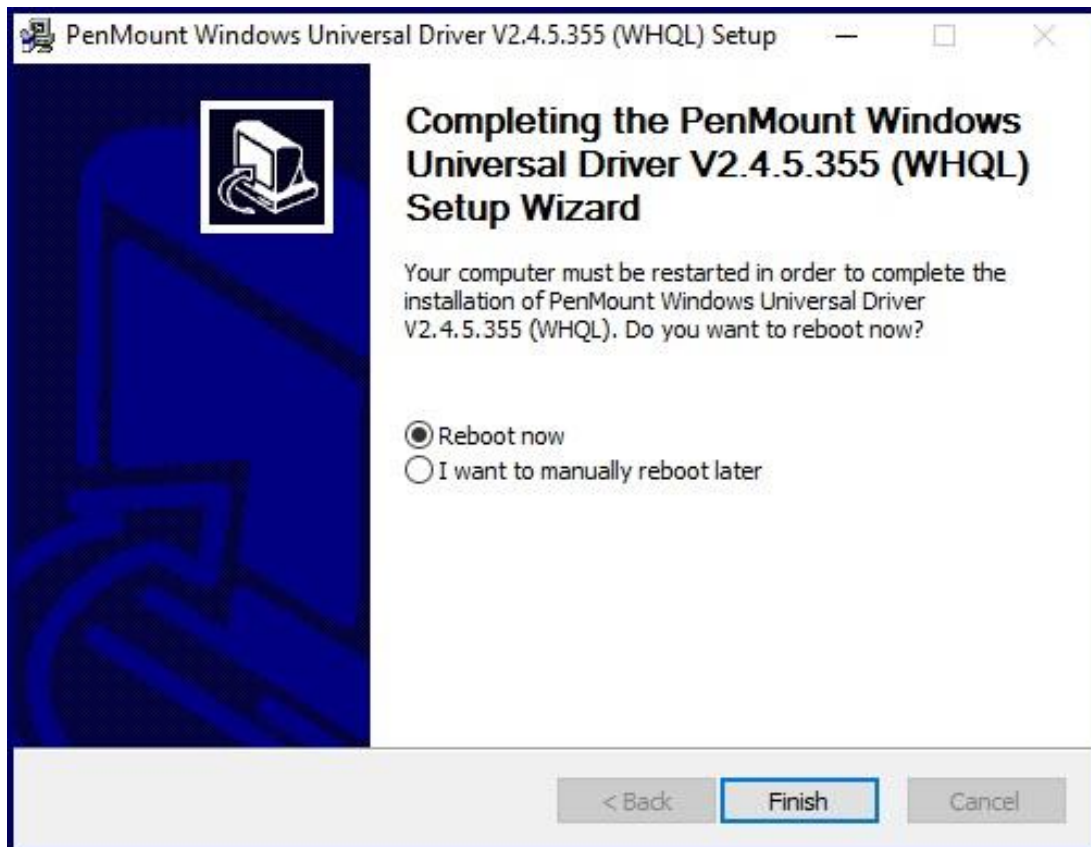

4.6.2 Software Functions

Resistive Touch

Upon rebooting, the computer automatically finds the new 6000 controller board. The touch screen is connected but not calibrated. Follow the procedures below to carry out calibration.

1. After installation, click the PenMount Monitor icon “PM” in the menu bar.
2. When the PenMount Control Panel appears, select a device to “Calibrate.”

PenMount Control Panel (Resistive Touch)

The functions of the PenMount Control Panel are **Device**, **Multiple Monitors**, **Tools** and **About**, which are explained in the following sections.

Device

In this window, you can find out that how many devices be detected on your system.

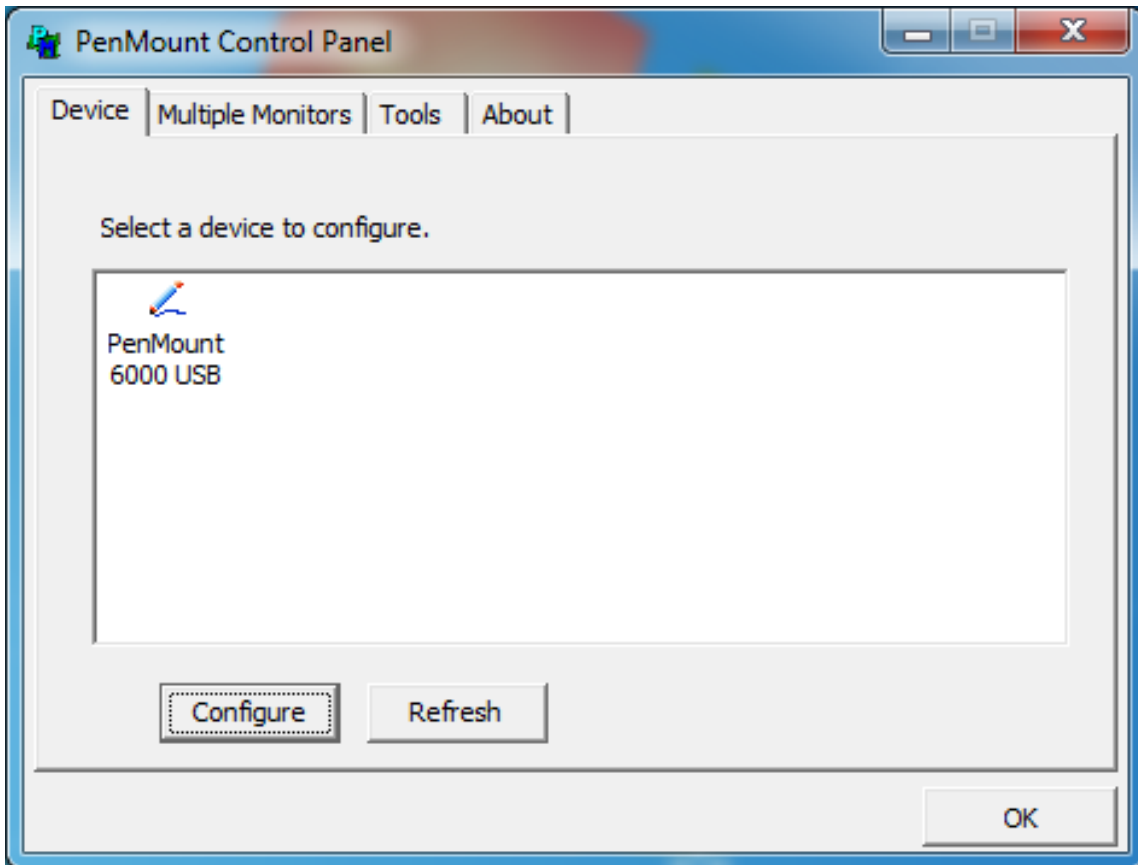

Calibrate

This function offers two ways to calibrate your touch screen. ‘Standard Calibration’ adjusts most touch screens. ‘Advanced Calibration’ adjusts aging touch screens.

Standard Calibration	Click this button and arrows appear pointing to red squares. Use your finger or stylus to touch the red squares in sequence. After the fifth red point calibration is complete. To skip, press ‘ESC’.
----------------------	--

Advanced Calibration	Advanced Calibration uses 4, 9, 16 or 25 points to effectively calibrate touch panel linearity of aged touch screens. Click this button and touch the red squares in sequence with a stylus. To skip, press ESC'.
----------------------	--

Step 1. Please select a device then click “Configure”. You can also double click the device too.

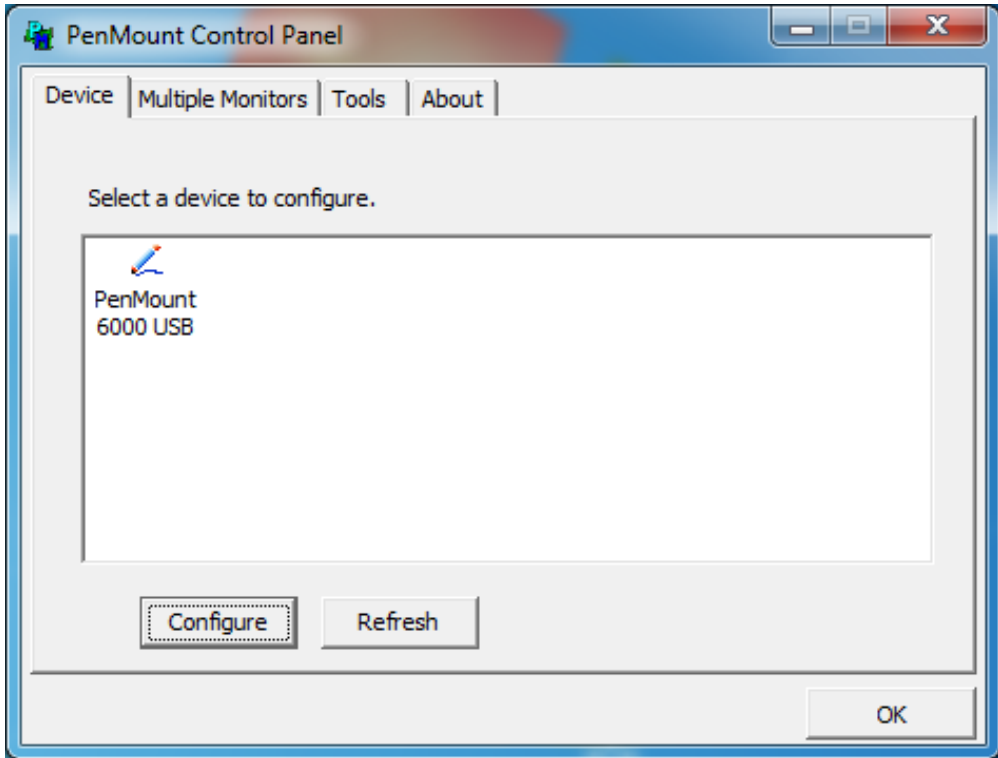

Step 2. Click “Standard Calibration” to start calibration procedure

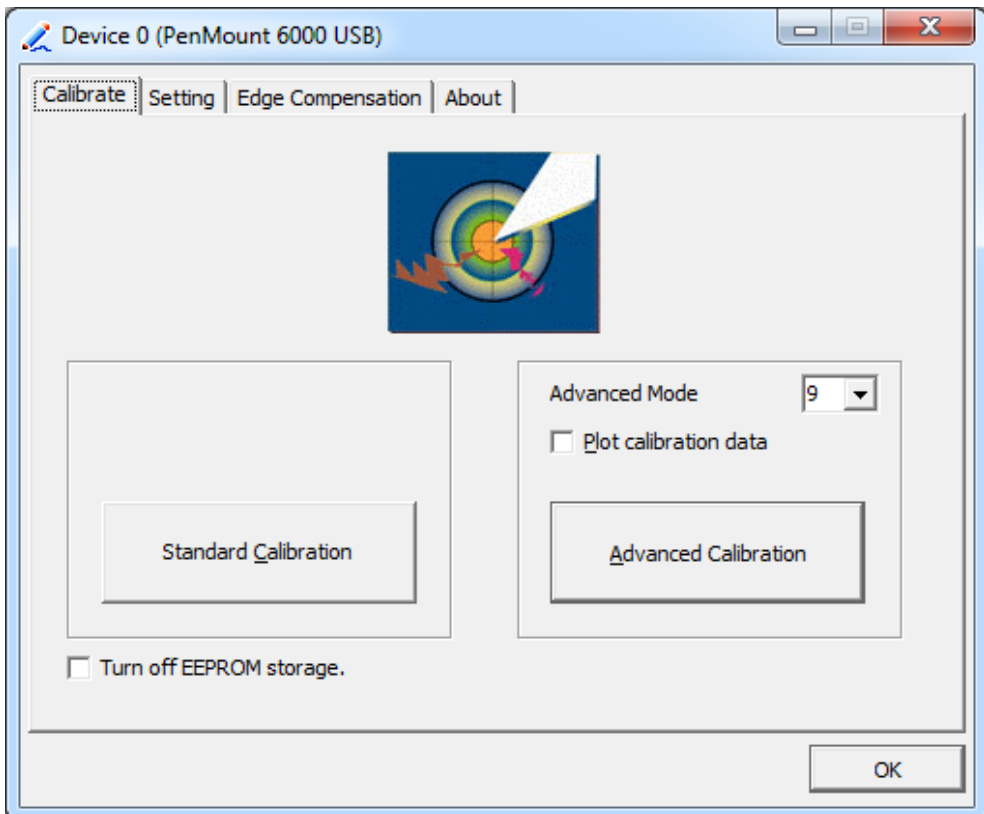

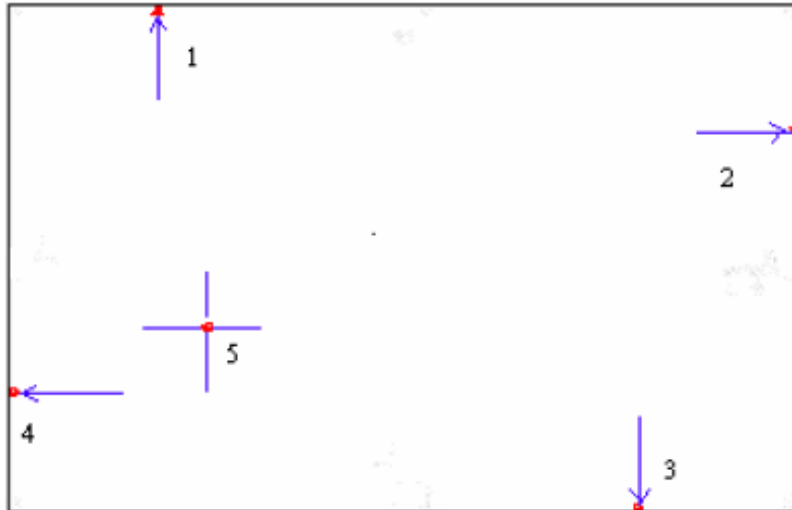

NOTE: The older the touch screen, the more Advanced Mode calibration points you need for an accurate calibration. Use a stylus during Advanced Calibration for greater accuracy. Please follow the step as below:

Step 3. Select **Device** to calibrate, then you can start to do **Advanced Calibration**.

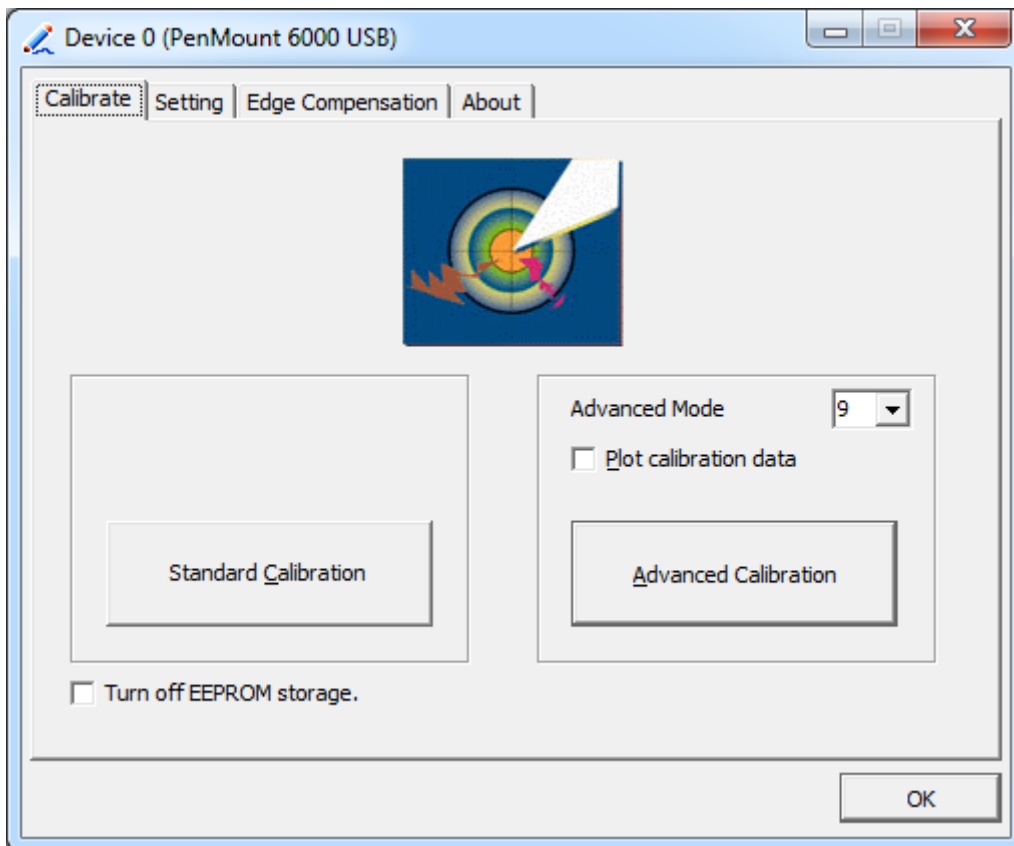

NOTE: Recommend to use a stylus during Advanced Calibration for greater accuracy.

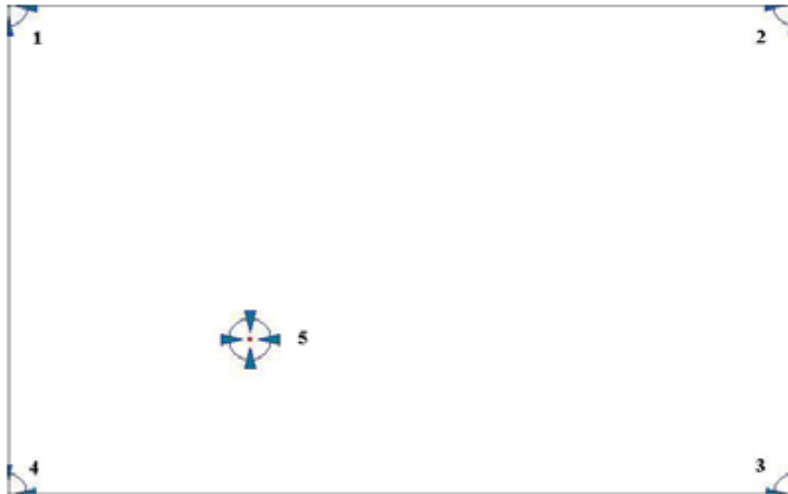

Plot Calibration Data	Check this function and a touch panel linearity comparison graph appears when you have finished Advanced Calibration. The blue lines show linearity before calibration and black lines show linearity after calibration.
Turn off EEPROM storage	The function disable for calibration data to write in Controller. The default setting is Enable.

Setting

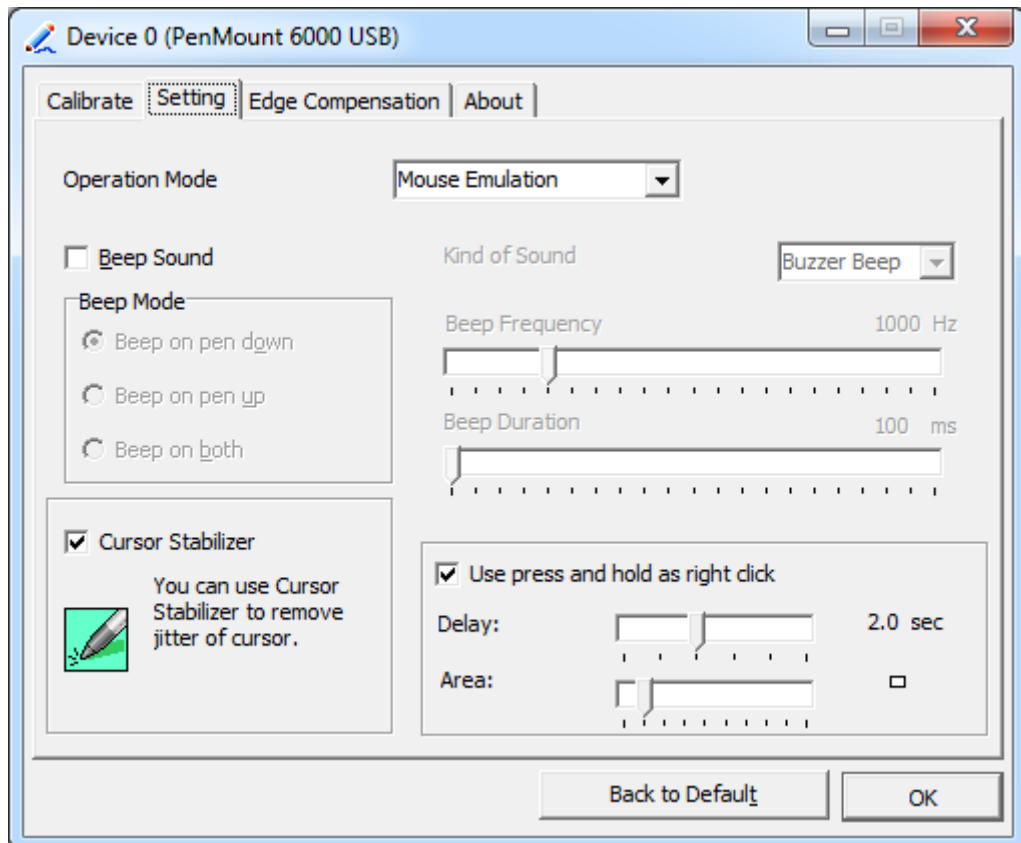

Touch Mode	This mode enables and disables the mouse’s ability to drag on-screen icons – useful for configuring POS terminals. Mouse Emulation – Select this mode and the mouse functions as normal and allows dragging of icons. Click on Touch – Select this mode and mouse only provides a click function, and dragging is disables.
Beep Sound	Enable Beep Sound – turns beep function on and off Beep on Pen Down – beep occurs when pen comes down Beep on Pen Up – beep occurs when pen is lifted up Beep on both – beep occurs when comes down and lifted up Beep Frequency – modifies sound frequency Beep Duration – modifies sound duration
Cursor Stabilizer	Enable the function support to prevent cursor shake.
Use press and hold as right click	You can set the time out and area for you need.

Edge Compensation

You can use Edge Compensation to calibrate more subtly.

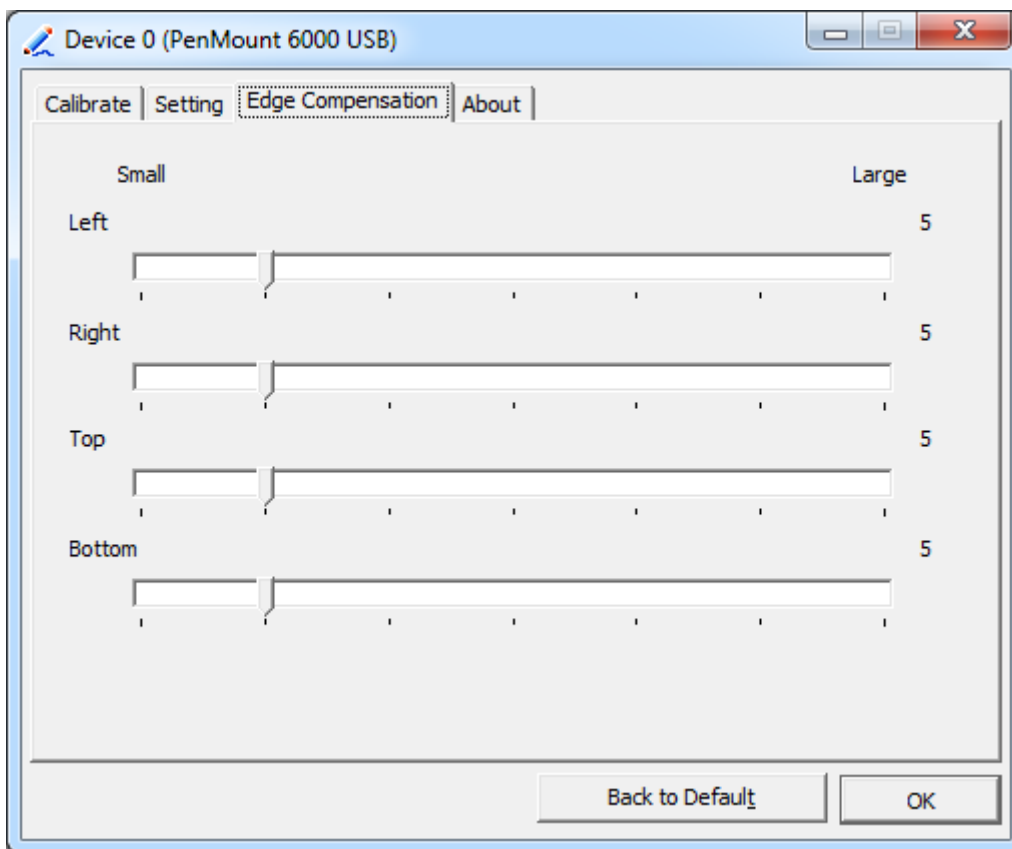

About

This panel displays information about the PenMount controller and driver version.

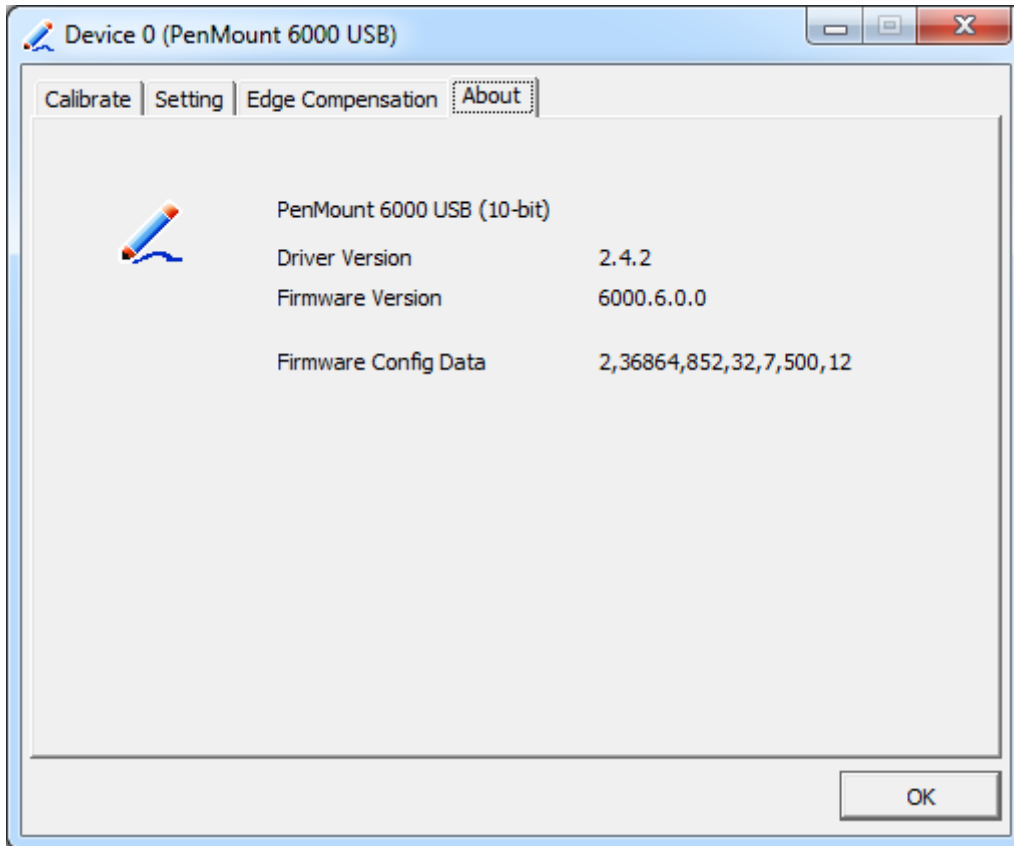

Multiple Monitors

Multiple Monitors support from two to six touch screen displays for one system. The PenMount drivers for Windows 7/8/8.1 support Multiple Monitors. This function supports from two to six touch screen displays for one system. Each monitor requires its own PenMount touch screen control board, either installed inside the display or in a central unit. The PenMount control boards must be connected to the computer COM ports via the USB interface. Driver installation procedures are the same as for a single monitor. Multiple Monitors support the following modes:
Windows Extends Monitor Function
Matrox DualHead Multi-Screen Function
nVidia nView Function

NOTE: The Multiple Monitor function is for use with multiple displays only. Do not use this function if you have only one touch screen display. Please note once you turn on this function the rotating function is disabled.

Enable the multiple display function as follows:

1. Check the **Enable Multiple Monitor Support** box; then click **Map Touch Screens** to assign touch controllers to displays.

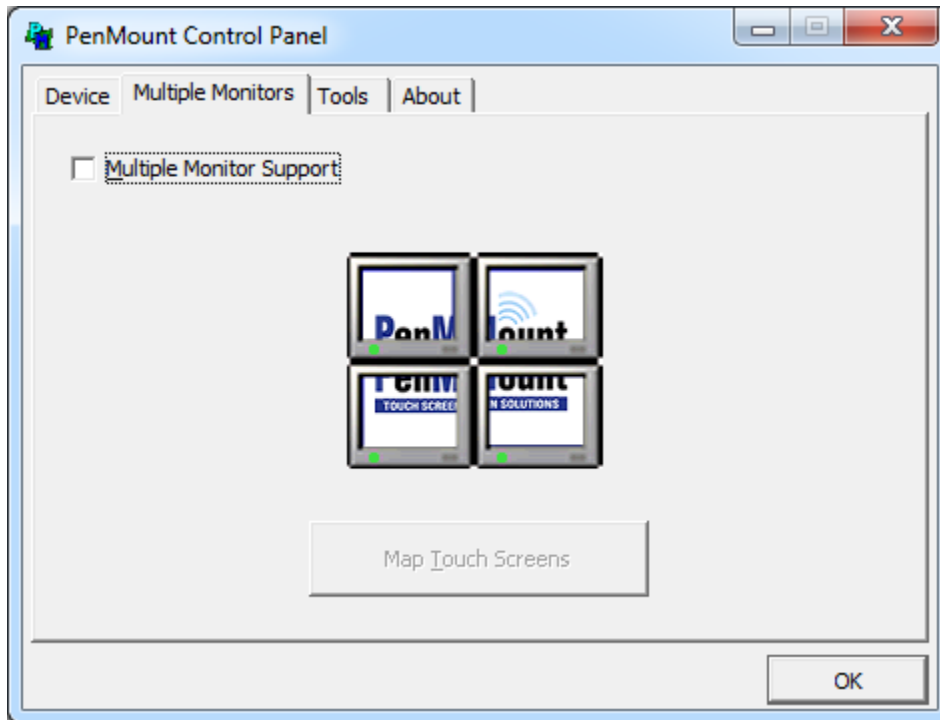

2. When the mapping screen message appears, click **OK**.
3. Touch each screen as it displays “Please touch this monitor”. Following this sequence and touching each screen is called **mapping the touch screens**.



4. Touching all screens completes the mapping and the desktop reappears on the monitors.
5. Select a display and execute the “Calibration” function. A message to start calibration appears. Click **OK**.

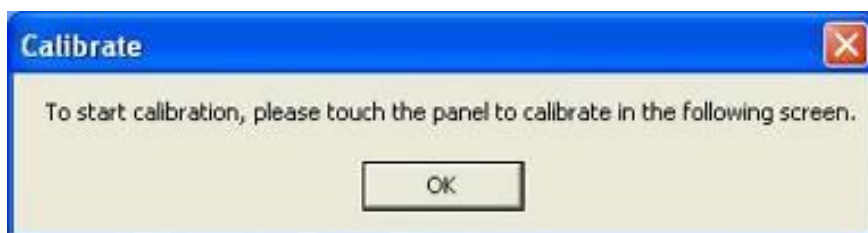

6. “Touch this screen to start its calibration” appears on one of the screens. Touch the screen.
7. “Touch the red square” messages appear. Touch the red squares in sequence.
8. Continue calibration for each monitor by clicking **Standard Calibration** and touching the red squares.

NOTES:

1. If you use a single VGA output for multiple monitors, please do not use the **Multiple Monitor** function. Just follow the regular procedure for calibration on each of your desktop monitors.
2. The Rotating function is disabled if you use the Multiple Monitor function.
3. If you change the resolution of display or screen address, you have to redo **Map Touch Screens**, so the system understands where the displays are.

About

This panel displays information about the PenMount controller and this driver version.

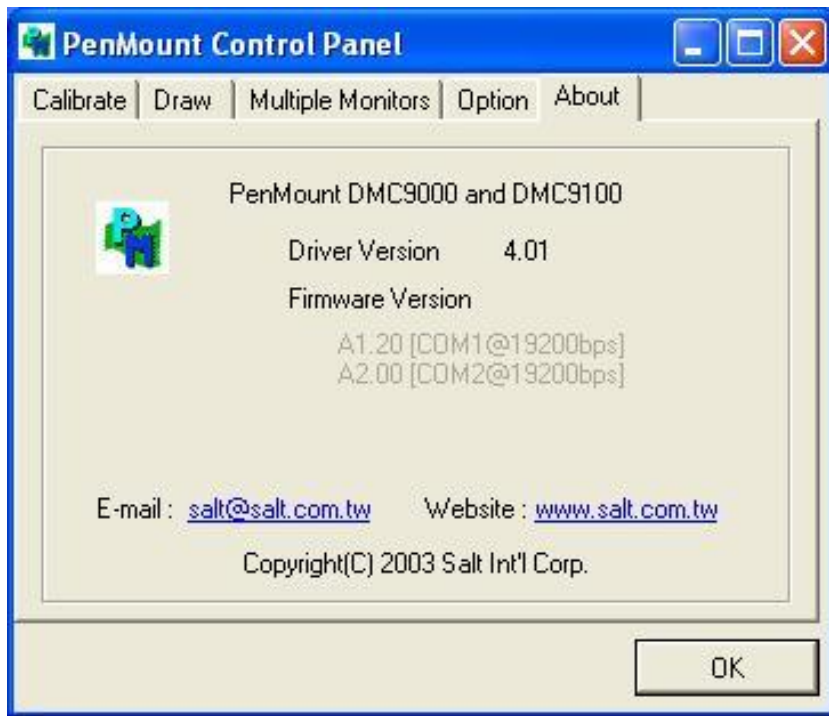

PenMount Monitor Menu Icon

The PenMount monitor icon (PM) appears in the menu bar of Windows 7/8/8.1 system when you turn on PenMount Monitor in PenMount Utilities.



PenMount Monitor has the following function



Control Panel	Open Control Panel Windows
---------------	-----------------------------------

Beep	Setting Beep function for each device
Right Button	<p>When you select this function, a mouse icon appears in the right-bottom of the screen.</p> <p>Click this icon to switch between Right and Left Button functions.</p> 
Exit	Exits the PenMount Monitor function.

Configuring the Rotate Function

1. Install the rotation software package.
2. Choose the rotate function (0°, 90°, 180°, 270°) in the 3rd party software. The calibration screen appears automatically. Touch this point and rotation is mapped.

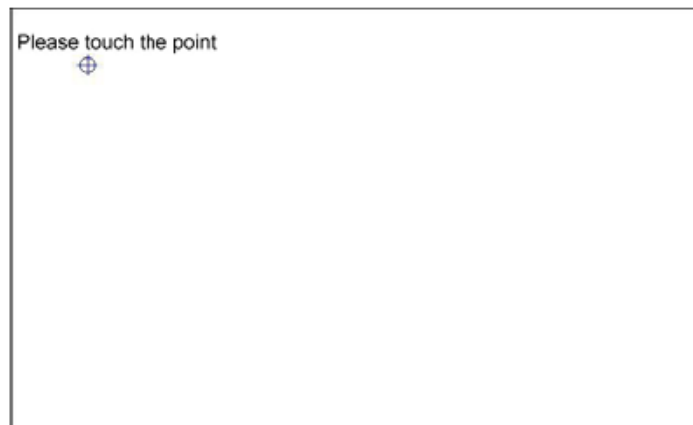

NOTE: The Rotate function is disabled if you use Monitor Mapping